

# Advanced Strategy Guideline: Air Distribution Basics and Duct Design

Arlan Burdick  
*IBACOS, Inc.*

December 2011

## NOTICE

This report was prepared as an account of work sponsored by an agency of the United States government. Neither the United States government nor any agency thereof, nor any of their employees, makes any warranty, express or implied, or assumes any legal liability or responsibility for the accuracy, completeness, or usefulness of any information, apparatus, product, or process disclosed, or represents that its use would not infringe privately owned rights. Reference herein to any specific commercial product, process, or service by trade name, trademark, manufacturer, or otherwise does not necessarily constitute or imply its endorsement, recommendation, or favoring by the United States government or any agency thereof. The views and opinions of authors expressed herein do not necessarily state or reflect those of the United States government or any agency thereof.

Available electronically at <http://www.osti.gov/bridge>

Available for a processing fee to U.S. Department of Energy  
and its contractors, in paper, from:

U.S. Department of Energy  
Office of Scientific and Technical Information  
P.O. Box 62  
Oak Ridge, TN 37831-0062  
phone: 865.576.8401  
fax: 865.576.5728

email: <mailto:reports@adonis.osti.gov>

Available for sale to the public, in paper, from:

U.S. Department of Commerce  
National Technical Information Service  
5285 Port Royal Road  
Springfield, VA 22161  
phone: 800.553.6847  
fax: 703.605.6900

email: [orders@ntis.fedworld.gov](mailto:orders@ntis.fedworld.gov)

online ordering: <http://www.ntis.gov/ordering.htm>



## **Advanced Strategy Guideline: Air Distribution Basics and Duct Design**

Prepared for:  
Building America  
Building Technologies Program  
Office of Energy Efficiency and Renewable Energy  
U.S. Department of Energy

Prepared by:  
Arlan Burdick  
IBACOS, Inc.  
2214 Liberty Avenue  
Pittsburgh, Pennsylvania 15222

NREL Technical Monitor: Michael Gestwick  
Prepared under Subcontract Number KNDJ-0-40341-02  
Deliverable 11.5.2  
October 2011

**[This page left blank]**

## Contents

<b>List of Figures</b> .....	<b>iv</b>
<b>List of Tables</b> .....	<b>v</b>
<b>Definitions</b> .....	<b>vi</b>
<b>Executive Summary</b> .....	<b>viii</b>
<b>1 Overview</b> .....	<b>1</b>
<b>2 Performance Criteria</b> .....	<b>4</b>
2.1 Temperature Mixing and Uniformity.....	4
2.1.1 Volume and Pressure of Air.....	4
2.1.2 Ductwork Materials and Configuration .....	4
2.2 Supply Outlets.....	5
2.2.1 Impact on Uniformity .....	5
2.2.2 Throw .....	6
2.3 Noise .....	7
<b>3 Integrated Design</b> .....	<b>10</b>
<b>4 Design Principles</b> .....	<b>12</b>
4.1 Pressure Drop.....	12
4.2 Room-by-Room Supply Requirements.....	14
4.3 Return Air Design .....	16
4.4 Supply Air Outlets .....	22
4.5 Duct Layout .....	26
4.6 Duct Size.....	29
<b>5 Conclusion</b> .....	<b>33</b>
<b>6 References</b> .....	<b>34</b>

## List of Figures

Figure 1. HVAC design flow .....	2
Figure 2. General steps for air distribution design .....	3
Figure 3. Increased friction rate in compressed flexible duct.....	5
Figure 4. High sidewall supply outlet example .....	6
Figure 5. Ceiling supply outlet example .....	6
Figure 6. Example throw and spread of air outlets .....	7
Figure 7. Return placement introduces noise.....	8
Figure 8. Strategy to reduce return noise.....	9
Figure 9. Framing duct integration strategy.....	11
Figure 10. Pressure worksheet.....	13
Figure 11. Orlando House floor plan.....	15
Figure 12. Locate the return first.....	16
Figure 13. Orlando House return location .....	17
Figure 14. Chicago House return location.....	18
Figure 15. Over-the-door transfer.....	19
Figure 16. High/low through-the-wall transfer grille.....	20
Figure 17. Attic transfer duct .....	20
Figure 18. Poor return grille placement .....	21
Figure 19. Good design, high return .....	22
Figure 20. Select and size air outlets .....	22
Figure 21. Air supply outlet selection .....	23
Figure 22. Example supply outlet performance data .....	24
Figure 23. Orlando House family room and kitchen and nook area .....	25
Figure 24. Chicago House family room and kitchen and nook area.....	26
Figure 25. Duct layout.....	26
Figure 26. Orlando House layout.....	27
Figure 27. Chicago House main floor .....	28
Figure 28. Chicago House basement layout .....	29
Figure 29. Size ducts for airflow .....	30

\*Unless otherwise noted, all figures were created by IBACOS.

## List of Tables

<b>Table 1. Comparative NC Values .....</b>	<b>10</b>
<b>Table 2. Orlando House Room-by-Room Loads .....</b>	<b>14</b>
<b>Table 3. Chicago House Supply Pressure Loss.....</b>	<b>31</b>
<b>Table 4. Master Bedroom Duct Run .....</b>	<b>32</b>

\*Unless otherwise noted, all tables were created by IBACOS.

## Definitions

ACCA	Air Conditioning Contractors of America
ANSI	American National Standards Institute
ASHRAE	American Society of Heating, Refrigerating and Air-Conditioning Engineers
Available Pressure	The difference between the static pressure and the pressure against which the selected equipment can deliver the cubic feet per minute of air. This value is what is available in the design for duct and supply outlet pressure losses.
Btu	British thermal unit
Btu/h	Btu per hour
CF	Cooling factor
cfm	Cubic feet per minute
Coanda Effect	The tendency of moving air to attach itself to a surface and flow along it. As air from the supply outlet moves across the ceiling surface, a certain amount of friction occurs between the supply air and the ceiling surface. This resistance to the flow of the supply air pulls the supply air toward the ceiling surface, causing it stick to the surface.
Effective Length	The length of duct used for design purposes that includes the straight length of duct added to all the fitting equivalent lengths.
Equivalent Length	The amount of duct length added to a duct run by fittings. Often the equivalent length of a fitting can be equal to or longer than the straight duct lengths due to the additional friction of turning air.
Face Velocity	The velocity of supply air as it leaves the supply outlet.
Friction Rate	The pressure loss between two points in a duct system that are separated by a specific length. The units for friction rate are inches water column per 100 feet (iwc/100 ft).
ft/min	Feet per minute



HF	Heating factor
HVAC	Heating, ventilation, and air-conditioning
IECC	International Energy Conservation Code
iwc	Inch water column
Manual D	<i>ACCA Manual D—Residential Duct Systems</i>
Manual J	<i>ACCA Manual J—Residential Load Calculation</i>
Manual S	<i>ACCA Manual S—Residential Equipment Selection</i>
Manual T	<i>ACCA Manual T—Air Distribution Basics for Residential and Small Commercial Buildings</i>
NC	Noise criteria
Spread	The width of the air stream leaving the supply outlet as determined by the characteristics of the supply outlet.
Static Pressure	The amount of pressure built up in the system by accessories such as the cooling coil or filters.
Terminal Velocity	The velocity of supply air at the end of its effective throw.
Throw	The effective distance that air leaving the supply outlet can reach.

## Executive Summary

Right-sizing of a heating, ventilation, and air-conditioning (HVAC) system is the selection of equipment and the design of the air distribution system to meet the accurate predicted heating and cooling loads of the house. The estimated heating and cooling loads are those required to meet the inside design conditions on the design load day. The design load day is not the most extreme weather conditions or the conditions that represent the majority of hours in a year. Temperature swings are expected in the conditioned space during extreme weather, and the system must be able to deliver comfort during the many hours of partial load conditions.

The higher performing house with higher levels of insulation, more energy efficient windows, reduced air infiltration, and controlled mechanical ventilation has a lower load, and consequently less air volume is needed to condition the space. This presents both challenges and opportunities when designing the air distribution system. Challenges arise when using air outlets sized by “rule of thumb” that do not have the throw needed to provide air mixing in the room to achieve the desired comfort results. At the same time, the energy efficient house design process offers opportunities to integrate the HVAC system into the design earlier in the process and to utilize a strategy of shorter duct runs with smaller cross-sectional areas that can reduce system costs and that can be installed completely within the conditioned space.

To illustrate the air distribution basics and the issues faced when implementing a robust duct design methodology for an energy efficient house, two theoretical houses that meet the 2009 International Energy Conservation Code (IECC) prescriptive path were modeled. The first was modeled in the IECC Climate Zone 5 - CZ5, Chicago, Illinois. The second was modeled in IECC Climate Zone 2 - CZ2, Orlando, Florida.

The performance criteria of a well-designed air distribution system include air delivery without inducing drafts or excessive noise. The occupied zone of a room, 2 feet away from walls and 2 feet off the ceiling, is the area where the perception of a draft must be avoided. Noise in the air distribution system comes from the velocity of air in the ducts, supply, or return and the air handling equipment itself. Strategies to avoid the comfort issues perceived as drafts or system noise are critical to the design of the HVAC system.

The air distribution system will give consideration to the return side of the system as well as the supply side. A well-designed return air strategy is critical for the performance of the HVAC system. Rooms without adequate return air can impede supply airflow due to overpressurization in the room, leading to comfort issues. Every room with a supply outlet (with the exception of bathrooms or kitchens due to the potential for spreading odors through the house) must have a clear return air pathway.

The selection and placement of the supply air outlets are critical to the comfort in the space. With the lower loads of the energy efficient house, the volume of air, measured in cubic feet per minute, required to condition the space is also lower, presenting challenges in selecting the air supply outlets. The air must be delivered in a manner that mixes the supply air with the room air without causing the sensation of a draft on the occupant.

Finally, decisions made during the early design phase are critical to the successful performance of the HVAC system. Early consideration of the HVAC system in an integrated design allows the designer to allocate adequate space for the equipment and ducts while identifying principal potential conflicts between the building's structure and the HVAC system.

## 1 Overview

The heating, ventilation, and air-conditioning (HVAC) system is arguably the most complex system installed in a house and is responsible for a substantial component of the total house energy use. A right-sized HVAC system will provide the desired comfort and will run efficiently. Right-sizing of an HVAC system is the selection of equipment and the design of the air distribution system to meet the accurate predicted heating and cooling loads of the house. Right-sizing the HVAC system begins with an accurate understanding of the heating and cooling loads on a space; however, a full HVAC design involves more than just the load estimate calculation; the load calculation is the first step of the iterative HVAC design procedure. This strategy guideline discusses the information needed to design the air distribution system to deliver the proper amount of conditioned air to a space. Heating and cooling loads are dependent upon the building location, sighting, and the construction of the house, whereas the equipment selection and the air distribution design are dependent upon the loads and each other.

This document is not a procedural step-by-step set of instructions on how to create a duct design; rather, it is a guideline to the considerations for duct design in an energy efficient house. The procedures of residential HVAC design (see Figure 1) are covered in detail by a series of publications produced by the Air Conditioning Contractors of America (ACCA), which in turn references information provided by the American Society of Heating, Refrigerating and Air-Conditioning Engineers (ASHRAE). The heat loss and gain values are estimated using the procedures from the ACCA publication, *Manual J—Residential Load Calculation*, Eighth Edition (Manual J) (Rutkowski 2006). Manual J applies only to single-family detached dwellings, low-rise condominiums, and town houses. Mechanical equipment selection is done with the aid of the ACCA *Manual S—Residential Equipment Selection* (Manual S) (Rutkowski 1995). The ductwork to convey the proper amount of conditioned air to meet the load requirements of the space can be designed with the aid of the ACCA *Manual D—Residential Duct Systems* (Manual D) (Rutkowski 2009). Conditioned air delivery to the space is controlled by the type and size of the air outlet, as discussed in the ACCA *Manual T—Air Distribution Basics for Residential and Small Commercial Buildings* (Manual T) (Rutkowski 1992). Manual T provides guidance on selecting the air outlet size, type, and location. The ACCA procedures have been written into commercial software packages to help the designer work through the iterations required for a good design. While commercial software is an important tool for design, it should be operated with a solid understanding of the procedures and intentions of proper HVAC design.

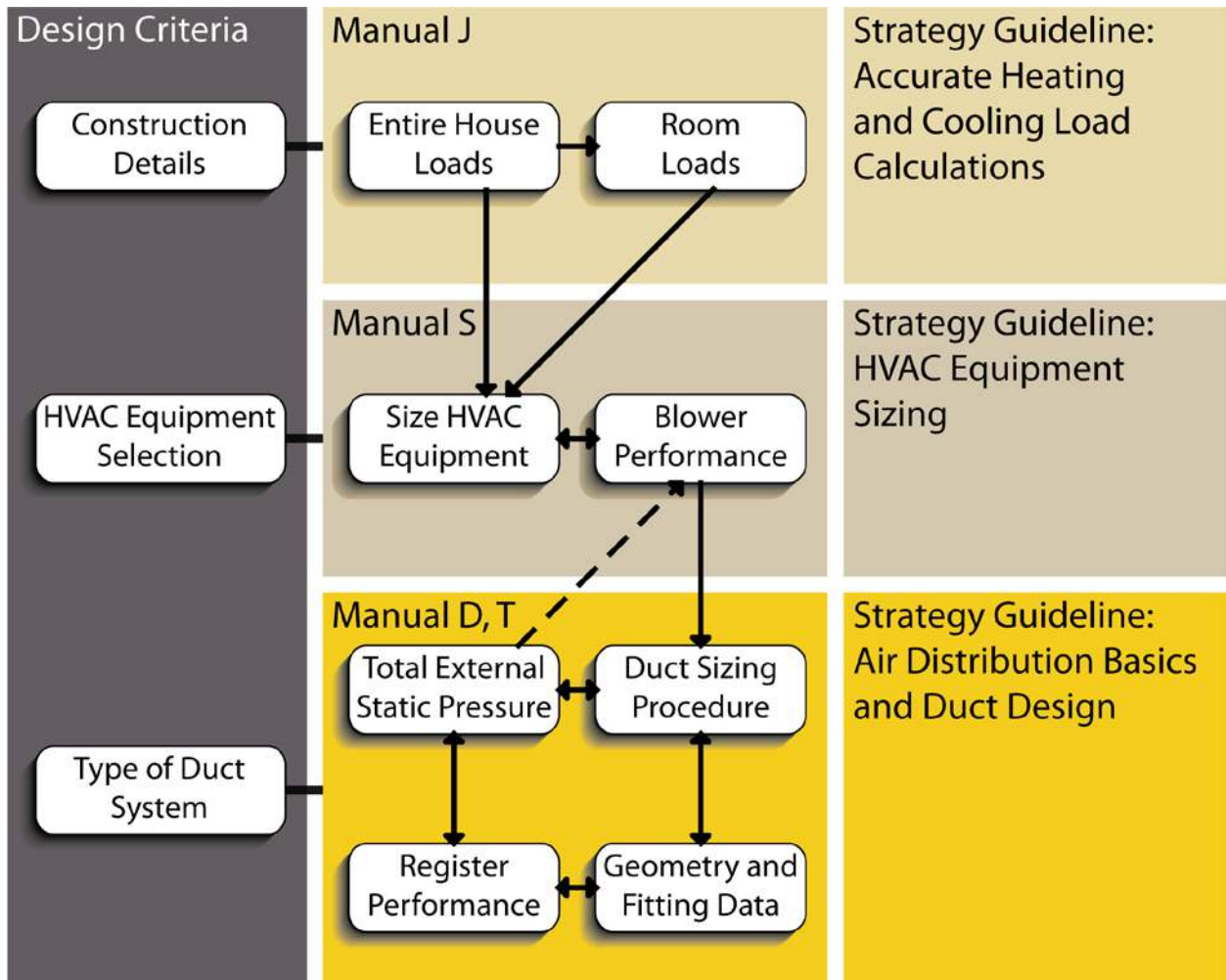


Figure 1. HVAC design flow

For the purposes of this Strategy Guideline, an energy efficient house is defined as one that is designed and built for decreased energy use and improved comfort through higher levels of insulation, more energy efficient windows, high efficiency space conditioning and water heating equipment, energy efficient lighting and appliances, reduced air infiltration, and controlled mechanical ventilation. Specification levels for energy efficient houses have historically been prescribed by beyond code programs that set a percentage better than code for energy use, such as ENERGY STAR<sup>®</sup>, which requires houses to be 15% more energy efficient than code. Beyond code programs continue to set a percentage better than the improved codes for energy use, raising the bar for whole house energy efficiency. The 2009 International Energy Conservation Code (IECC) establishes an estimated 15% improvement in energy efficiency over the previous 2006 IECC requirements. Ongoing code cycles incrementally increase the minimum efficiency of a house. For example, the 2012 IECC achieves approximately 30% savings over the 2006 version. As the new codes are adopted and implemented, a house that was built under an above code program in 2010 will likely be the code mandated house in 2015. As the energy efficiency

of the house is increased under code or above code programs, the peak heating and cooling loads are significantly reduced.

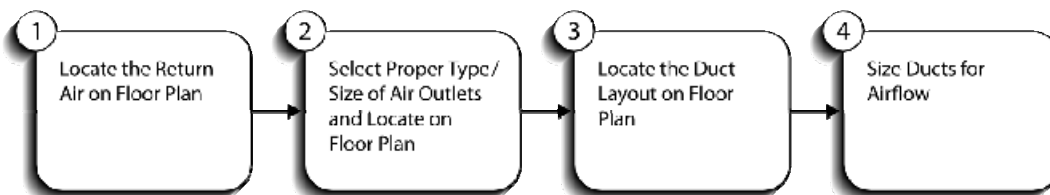
To illustrate the procedures of HVAC equipment selection, two theoretical houses that meet the 2009 IECC prescriptive path were modeled. The first house (the “Chicago House”) is a one-story, 2,223-square-foot (above-grade) house that has a full conditioned basement and is located in Chicago, Illinois (IECC Climate Zone 5 - CZ5). The other house (the “Orlando House”) is a one-story 2,223-square-foot slab-on-grade house in Orlando, Florida (IECC Climate Zone 2 - CZ2).

In addition to the climatic differences between the two house locations, the Chicago House is a house over a full basement, whereas the Orlando house is a slab-on-grade foundation, allowing for the discussion of different mechanical and ductwork layouts.

The impacts and importance of accurately estimating heating and cooling loads are covered in depth in the U.S. Department of Energy Building America *Strategy Guideline: Accurate Heating and Cooling Load Calculations* (Burdick 2011a). The equipment selection to satisfy those estimated loads is discussed in the U.S. Department of Energy Building America *Strategy Guideline: HVAC Equipment Sizing* (Burdick 2011b). This Strategy Guideline on air distribution basics and duct design for an energy efficient house builds upon the information developed in those two previous guides. Results of the load calculations and the equipment selected in the two previous guidelines are used for the air distribution examples here.

The estimated heating and cooling loads are those required to meet the inside design conditions on the design load day. The design load day is not the most extreme weather condition or the conditions that represent the majority of hours in a year. Therefore, temperature swings are expected in the conditioned space during extreme weather, and the system must be able to deliver comfort during the many hours of partial load conditions. The higher performing house has a lower load, and consequently less air volume is needed to condition the space. This presents both challenges and opportunities when designing the air distribution system. Challenges arise when using air outlets sized by “rule of thumb” that do not have the throw needed to provide air mixing in the room to achieve the desired comfort results. At the same time, the energy efficient house design process offers opportunities to integrate the HVAC system into the design earlier in the process and to utilize a strategy of shorter duct runs with smaller cross-sectional areas that can reduce system costs and that can be more easily installed completely within the conditioned space.

In general, the primary considerations for the air distribution design are shown in Figure 2.



**Figure 2. General steps for air distribution design**

## 2 Performance Criteria

Occupant comfort is the overall objective of the HVAC system, and air distribution is the means of delivering conditioned air to provide comfort in the room. Comfort is very subjective and can vary by individual activities and metabolic rates. The principal comfort criteria related to the air distribution system are temperature mixing and uniformity, drafts that can be created by the supply outlets, and system noise.

### 2.1 Temperature Mixing and Uniformity

Temperature in the room is maintained by delivering just the proper amount of air in a manner in which this air can mix with the air that is already in the room. ACCA (2009) offers guidance for dry-bulb temperature variances from the thermostat setting during the heating season as measured at the thermostat to be  $\pm 2^{\circ}\text{F}$ . Similarly the temperature during the heating season in any room should be  $\pm 2^{\circ}\text{F}$  of the thermostat set temperature. Room-to-room temperature differences or floor-to-floor temperature differences should be no greater than  $4^{\circ}\text{F}$  in the heating season. ACCA guidance for room temperature variances from the thermostat setting is  $\pm 3^{\circ}\text{F}$  during the cooling season.

#### 2.1.1 Volume and Pressure of Air

The amount of air available to provide comfort to the rooms is determined by the equipment selected to meet the loads of the house. In energy efficient houses with lower loads, properly selected equipment will have less capacity to supply air, and the performance of the system is dependent upon making the best use of the available air. The volume of air the equipment is rated to deliver is determined at a specific pressure. Every item, including the ductwork used in the airway, adds to the pressure loss within the system.

#### 2.1.2 Ductwork Materials and Configuration

The ductwork that is used to achieve the delivery of air from the equipment to the room can have a great impact on comfort in the room. The capacity of a duct to carry air is affected by the resistance within the duct. Typical materials used to make up ductwork are galvanized steel that can be formed into round or rectangular shapes, foil-faced fiberglass duct board that can be formed into angular shapes in the field, or an insulated flexible fabric round duct. Due to the varying friction factors of the different materials, the type of material must be considered in the design process. Increased friction or duct length adds to the total pressure loss. Galvanized steel material ductwork has a lower friction rate than that of flexible duct due to the smoother inside surface of the steel duct; therefore, the fittings chosen will have a greater impact on friction losses in the system. Because air travels easiest in a straight line, a turn in the ductwork will increase the effective length of the duct by more than just the physical length of the turn. For example, a  $90^{\circ}$  bend will add as much as 35 additional feet of effective length to a duct run, depending on the construction of the ducts. Effective length values for common fittings are listed in Appendix 3 of ACCA Manual D (Rutkowski 2009).

The success of a design in either flexible duct or rigid duct depends upon the faithful execution of the design during installation. The ACCA Standard 5 HVAC Installation Specification (ACCA 2010) was introduced in 2010 as an American National Standards Institute (ANSI) standard to improve the core competencies of contractors and to ensure that quality installations

occur. Figure 3 shows how installing flexible duct in its compressed form can increase the friction rate exponentially due to the increased roughness inside the compressed duct.



**Figure 3. Increased friction rate in compressed flexible duct**

## 2.2 Supply Outlets

### 2.2.1 Impact on Uniformity

When selecting supply outlets, the designer must consider the “occupied zone” of the space to be 2 feet off walls and 6 feet above the floor to avoid drafts. Drafts caused by airflow within the occupied zone can be considered a comfort issue. The amount of airflow that may be perceived as a draft can be relatively low. Air at a velocity of 15 feet per minute may allow smoke to hang in the air, whereas a piece of paper may blow off a desk at an air velocity of 65 feet per minute. The target terminal velocity or the velocity at the useful end of an air stream is between 50 and 75 feet per minute; therefore, if this air stream is directed into the occupied zone, a complaint of a draft is likely.

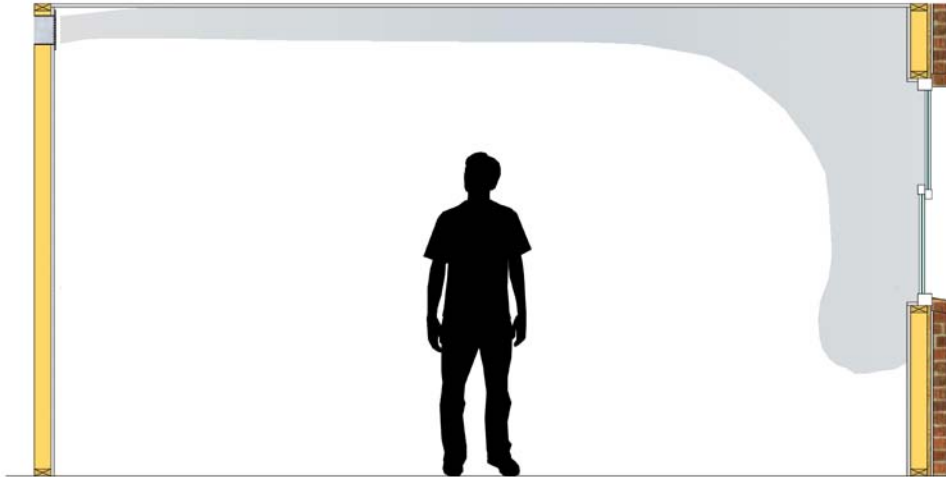
Supply outlet – The device that introduces supply air to the space.

Pressure loss associated with the supply outlets must be considered when selecting the type of air outlet and must be added to the entire duct run pressure loss.

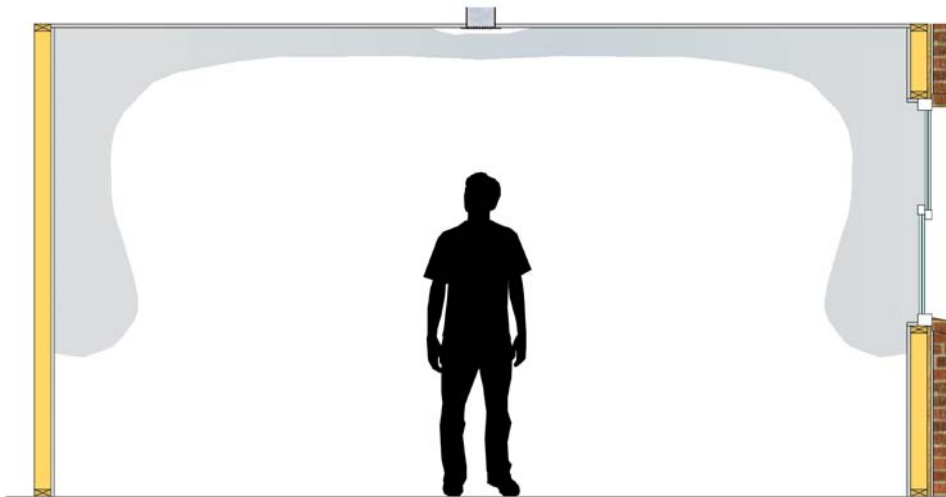
The proper amount of air is determined by the room-by-room heating and cooling loads. Too little air delivered to a room results in underheating or undercooling, whereas too much air delivered to a room results in overheating or overcooling. To maintain a uniform temperature and to avoid stratification, the supply air must also adequately mix the air in the room.



Mixing of air within the room is a function of the supply outlet and the shape of the air stream entering the room. Figure 4 shows the general concept of a high sidewall supply air delivery pattern, and Figure 5 shows the general concept of a ceiling supply outlet air delivery pattern.



**Figure 4. High sidewall supply outlet example**



**Figure 5. Ceiling supply outlet example**

### **2.2.2 Throw**

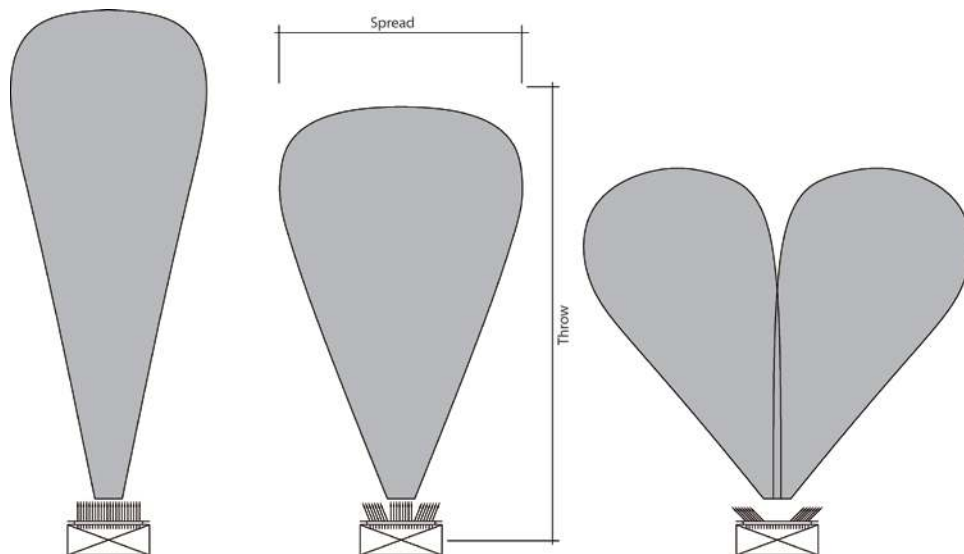
By delivering the supply air to the ceiling, the designer is taking advantage of the Coanda effect of air sticking to a surface to increase the throw of the supply outlet. The Coanda effect is a low pressure area that develops between the air stream and the ceiling, allowing the air stream to travel along the ceiling and further increasing the throw.

**Coanda effect** – The tendency of moving air to attach itself to a surface and flow along it. As air from the supply outlet moves across the ceiling surface, a certain amount of friction occurs between the supply air and the ceiling surface. This resistance to the flow of the supply air pulls the supply air toward the ceiling surface, causing it to stick to the surface.

Throw is the maximum distance the air can reach effectively at a given face velocity and terminal velocity. Air outlets are categorized by the throw as well as the spread (i.e., the width of the air stream), as shown in Figure 6.

The throw of an outlet is more important than the spread because the air must reach into the room as far as possible for good mixing. A narrow spread can be overcome with the use of additional outlets if necessary. It is important that any air exiting multiple outlets does not collide in the room because this will cause the undesired sensation of a draft. If the supply outlets are to be placed perpendicular to each other in a room, then adjustable blades are desirable to be able to direct the air streams so that they do not collide.

<p><b>Face velocity</b> – The velocity of supply air as it leaves the supply outlet.</p>
<p><b>Terminal velocity</b> – The velocity of supply air at the end of its effective throw.</p>
<p><b>Throw</b> – The effective distance that air leaving the supply outlet can reach.</p>
<p><b>Spread</b> – The width of the air stream leaving the supply outlet as determined by the characteristics of the supply outlet.</p>

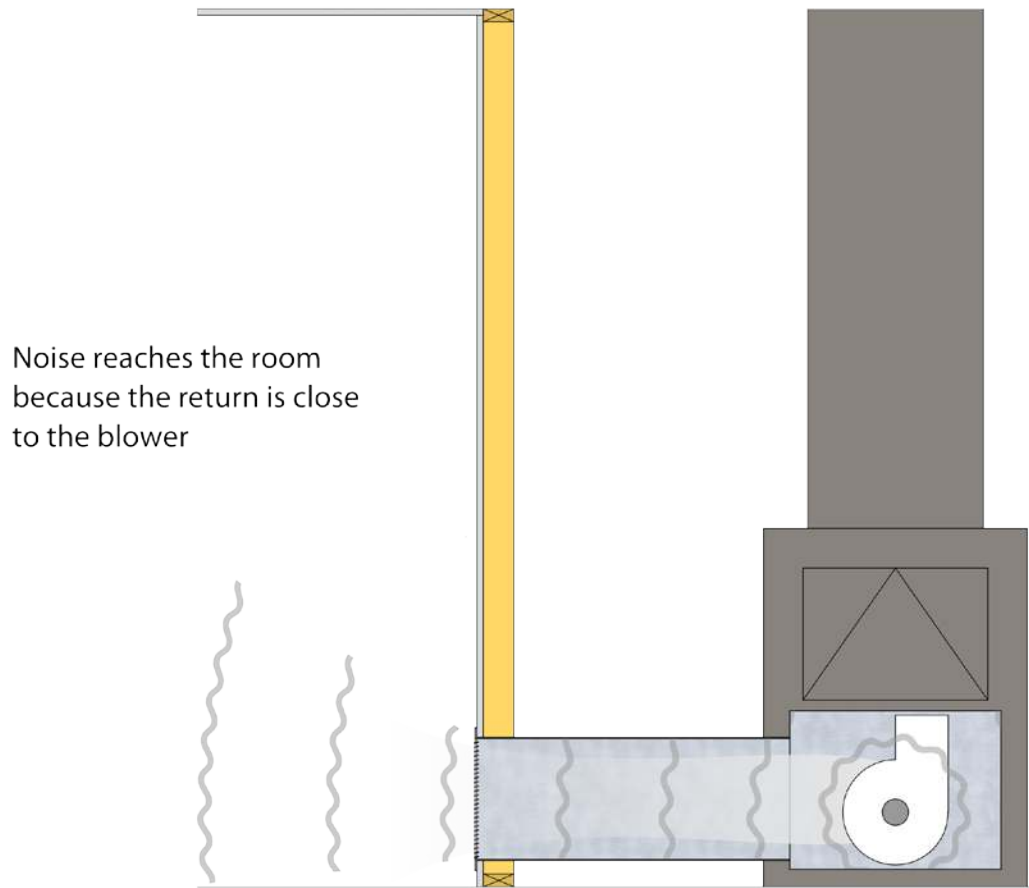


**Figure 6. Example throw and spread of air outlets**

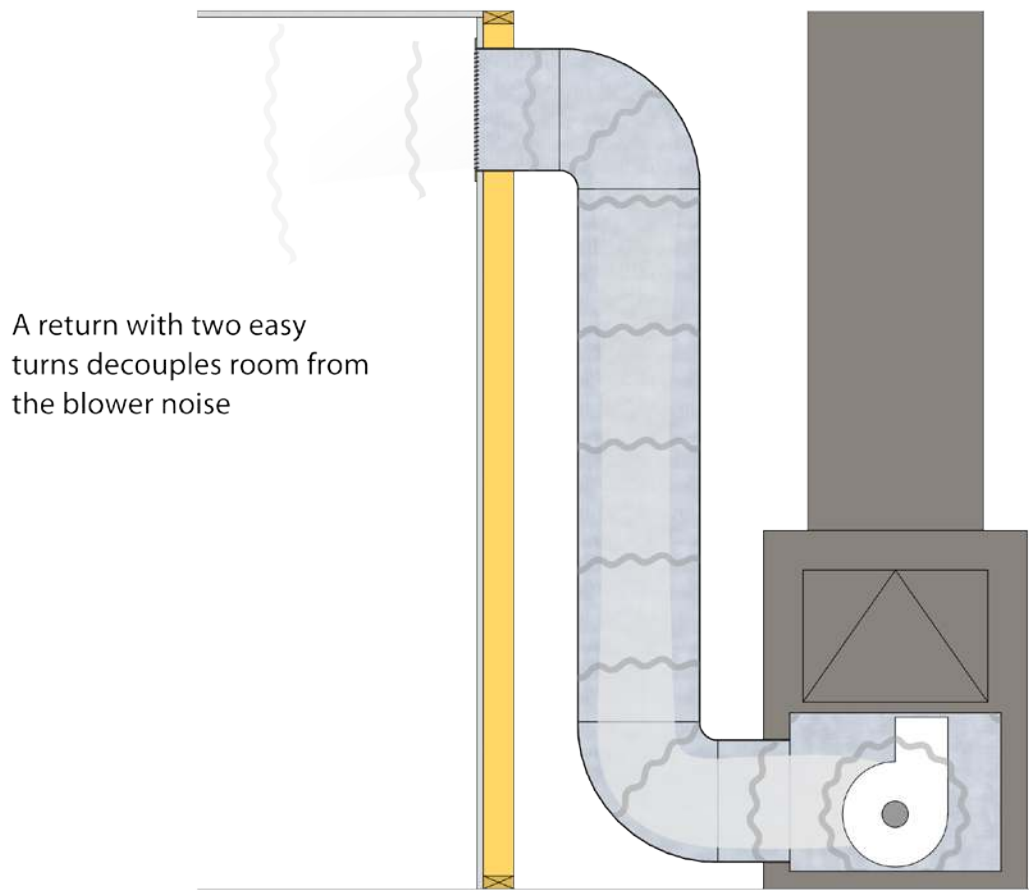
### 2.3 Noise

Noise from the equipment, ducts, or air outlets is an important part of the comfort equation. The placement of the equipment within the conditioned space will increase energy efficiency; however, the placement of the equipment must consider the impact of the equipment noise during operation. Placing equipment close to important noise control areas such as bedrooms must involve consideration of the implications from the equipment noise and vibrations.

The placement of the return air inlet can also have an impact on system noise. A return duct that has a direct connection to the blower motor, as shown in Figure 7, will transfer that blower noise to the occupied space. One way to overcome this issue is by adding radius elbows in the return duct to help isolate the blower noise from the space, as shown in Figure 8.



**Figure 7. Return placement introduces noise**



**Figure 8. Strategy to reduce return noise**

As air speed increases in duct systems, so does the noise level. Ducts are sized to maintain the maximum velocity of air without adding noise to the room. The type of air outlet chosen and its placement in the room will have an impact on the noise levels in the house. Air that leaves an air outlet at a higher velocity than the outlet is intended to handle will create an undesirable whistling or hissing noise. Improperly placed or selected air outlets can also create a draft in the occupied zone, which is a perceived comfort issue. When selecting an air outlet, the manufacturer's performance data will list a noise criteria (NC) rating based on a very specific set of testing data. The NC ratings are based on laboratory testing of the air outlets. It is important to realize that the listed criteria are for only that specific test situation; however, the data provide a comparative rating. The NC ratings for residential settings are NC 30 or lower. Table 1 shows how the NC ratings apply to familiar settings.

**Table 1. Comparative NC Values**

	<b>Communication Environment</b>	<b>Typical Occupancy</b>
<NC 25	Extremely quiet environment; suppressed speech is quite audible; suitable for acute pickup of all sounds.	Broadcasting studios, concert halls, music rooms.
NC 30	Very quiet office; suitable for large conferences; telephone use satisfactory.	Residences, theaters, libraries, executive offices, director's rooms.
NC 35	Quiet office; satisfactory for conference at a 15-foot table; normal voice 10 to 30 feet; telephone use satisfactory.	Private offices, schools, hotel guestrooms, courtrooms, churches, hospital rooms.
NC 40	Satisfactory for conferences at a 6- to 8-foot table; telephone use satisfactory.	General office, labs, dining rooms.
NC 45	Satisfactory for conferences at a 4- to 5-foot table; normal voice 3 to 6 feet; raised voice 6 to 12 feet; telephone use occasionally difficult.	Retail stores, cafeterias, lobby areas, large drafting and engineering offices, reception areas.
>NC 50	Unsatisfactory for conference of more than two or three persons; normal voice 1 to 2 feet; raised voice 3 to 6 feet; telephone use slightly difficult.	Computer rooms, stenographic pools, print machine rooms, process areas.

### 3 Integrated Design

The HVAC system must be considered in the early schematic design phase to achieve optimal performance in an energy efficient house. During the schematic phase, the design team needs to allocate adequate space for the equipment and ducts while identifying principal potential conflicts between the building's structure and the HVAC system. Decisions made during the early design phase will be critical to the successful performance of the HVAC system.

Locating the HVAC equipment centrally within the house is an early design consideration with many benefits for the performance of the system and implications for the space planning in the house. Locating the equipment centrally will allow for shorter duct runs with similar lengths, which can lead to a better balanced system and improved performance. Centrally located equipment with shorter duct runs also facilitates running ducts to interior walls with the high performance strategy of more efficient high sidewall diffusers aimed at the exterior walls.

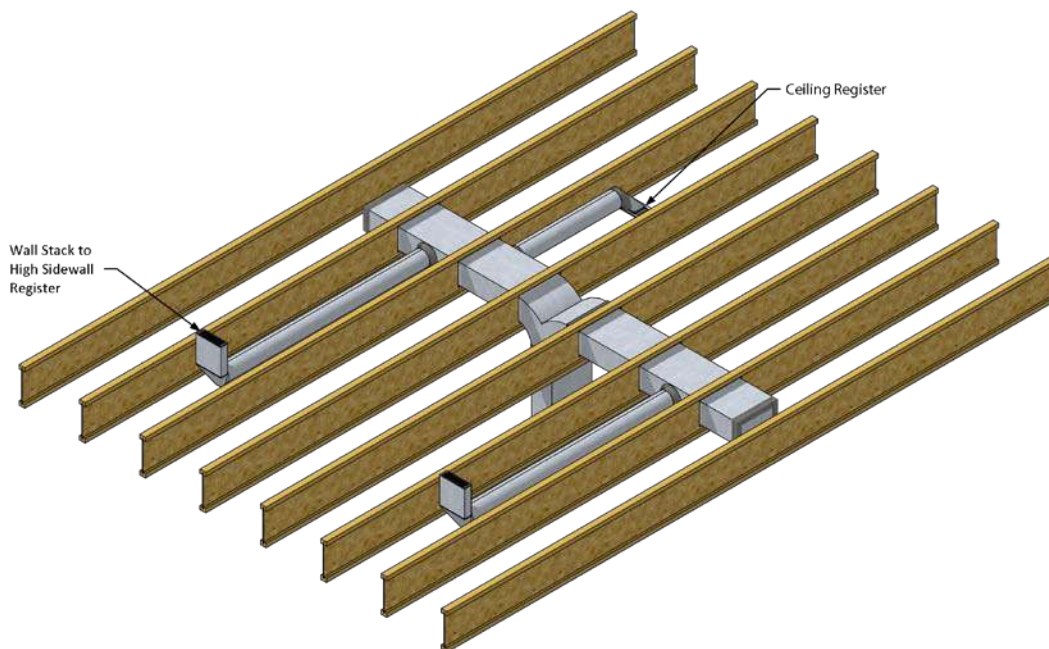
An energy efficient house utilizes strategies to keep all ductwork inside the thermal boundaries of the house. Keeping all ductwork inside thermal boundaries will eliminate losses to the outside of the building enclosure but may require the use of soffits that reduce ceiling heights or chases that must be designed with the floor plan flow.

A preliminary layout of the duct system can be made on the floor plan, taking into consideration the performance criteria. By considering a preliminary duct layout, early accommodations can be made in the framing plan as needed.

Floor systems are a commonly used element to run duct systems within the thermal boundary, particularly in multistory houses. Creating chases deliberately when designing the floor plan layout will allow the HVAC system to perform as designed. Considering the location of horizontal and vertical chases early in the design can decrease the level of complexity in the duct

runs by stacking the vertical chases and avoiding the reduced efficiencies and increased costs of a complex system layout. These designated chases should be clearly identified and set aside on the construction prints as “reserved” for HVAC. HVAC routing is much less flexible than plumbing and electrical, and the HVAC space should be clearly set aside in design documents. Aligning wall studs with the floor structural members facilitates horizontal to vertical duct transitions.

Early in the design stage, beneficial choices in framing materials can be made. As shown in Figure 9, floor joists can be cut to allow the HVAC contractor to route the ductwork both parallel and perpendicular to the floor framing. Following the joist manufacturer’s guidance on hole size and spacing is critical to the structural performance of the joist; however, with advance planning and design, these locations can be predetermined, thereby reducing the need for field fitting.



**Figure 9. Framing duct integration strategy**

The location of the return air duct system should also be determined early in the design process. Utilizing a central return strategy is a simple and effective way to move air back to the air handler. In locating a central return, it should be placed in a central hallway where it is adjacent to the main living space of the house. Strategies for locating the return air pathways from rooms not open to the central space are discussed in the Return Air Design section of this document.

Some preliminary information about the system airflows will need to be estimated because the size of the return duct system is designed to limit the pressure losses within the ductwork and the

size of the return will dictate where it can be placed. The placement of the central return duct is dictated by its size and the location of equipment.

The location of the return also affects the location of the filter, and the filter location will have a direct impact on the usability of the system. Placing filters in accessible locations will allow homeowners to easily replace the filters. In a house where the equipment is located in the basement and is easily accessible, placing the filter at the equipment return air inlet may be an appropriate choice. However, when equipment is located in the attic and is less accessible, a filter located at the return grille may be a better choice.

The use of building cavities as air passageways to deliver air to or from the HVAC system, such as wall cavities between studs and wallboard or floor cavities where material is used to box in floor joists, is not appropriate in an energy efficient house. A fully ducted return system will be easier to seal and will have better airflow characteristics than building cavities. Return air pathways that leak will draw air from unintended places in the house and can lead to undesirable pressure differences.

## 4 Design Principles

The distribution system must be designed to get the most out of the available air from the blower power that was selected based on the equipment manufacturer's performance data to meet the estimated heating and cooling loads. The blower capacity of the equipment selected will deliver a specific amount of air against a specific amount of system pressure. The resistance of the airflow within the distribution system must match the static pressure against which the equipment is able to perform. The ducts, fittings, supply outlets, and other accessories installed in the air stream all add to the pressure loss between the equipment and the outlets. The return system also adds to this system pressure loss and must be included in the design.

### 4.1 Pressure Drop

To ensure proper performance of the system, the pressure loss of each component of the system must be accounted for and subtracted from the available static pressure of the equipment. A worksheet such as the External Static Pressure Worksheet shown in Figure 10 can help the designer keep track of the various components with their associated pressure losses in the system. The sum of all the pressure losses will equal the total pressure drop, and the pressure drop must match the available static pressure of the equipment.

**Static Pressure** – A resistance to airflow due to the airflow restrictions created by coils, filters, elbows, grilles, duct friction, etc.

**Available Pressure** – The difference between the static pressure and the pressure against which the selected equipment can deliver the cubic feet per minute of air. This value is what is available in the design for duct and supply outlet pressure losses.

External Static Pressure Worksheet		
Builder.....	<input style="width: 95%;" type="text"/>	
Location.....	<input style="width: 95%;" type="text"/>	
Model.....	<input style="width: 95%;" type="text"/>	
<u>Device Pressure Losses</u>		<u>Comments</u>
Direct Expansion Refrigerant Coil.....	<input style="width: 50px;" type="text"/>	<input style="width: 100%; height: 20px;" type="text"/>
Electric Resistance Heating Coil.....	<input style="width: 50px;" type="text"/>	<input style="width: 100%; height: 20px;" type="text"/>
Hot Water Coil.....	<input style="width: 50px;" type="text"/>	<input style="width: 100%; height: 20px;" type="text"/>
Heat Exchanger.....	<input style="width: 50px;" type="text"/>	<input style="width: 100%; height: 20px;" type="text"/>
Low Efficiency Filter.....	<input style="width: 50px;" type="text"/>	<input style="width: 100%; height: 20px;" type="text"/>
High or Mid-Efficiency Filter.....	<input style="width: 50px;" type="text"/>	<input style="width: 100%; height: 20px;" type="text"/>
Electronic Filter.....	<input style="width: 50px;" type="text"/>	<input style="width: 100%; height: 20px;" type="text"/>
Humidifier.....	<input style="width: 50px;" type="text"/>	<input style="width: 100%; height: 20px;" type="text"/>
Supply Outlet.....	<input style="width: 50px;" type="text"/>	<input style="width: 100%; height: 20px;" type="text"/>
Return Grille.....	<input style="width: 50px;" type="text"/>	<input style="width: 100%; height: 20px;" type="text"/>
Balancing Damper.....	<input style="width: 50px;" type="text"/>	<input style="width: 100%; height: 20px;" type="text"/>
Other Device.....	<input style="width: 50px;" type="text"/>	<input style="width: 100%; height: 20px;" type="text"/>
Subtotal.....	<input style="width: 50px;" type="text"/> IWC	<input style="width: 100%; height: 20px;" type="text"/>
<u>Duct System Pressure Losses</u>		
Supply-side Pr. Loss.....	<input style="width: 50px;" type="text"/>	<input style="width: 100%; height: 20px;" type="text"/>
Return-side Pr. Loss.....	<input style="width: 50px;" type="text"/>	<input style="width: 100%; height: 20px;" type="text"/>
Subtotal.....	<input style="width: 50px;" type="text"/> IWC	<input style="width: 100%; height: 20px;" type="text"/>
Total Pressure Loss.....	<input style="width: 50px;" type="text"/> IWC	<input style="width: 100%; height: 20px;" type="text"/>
<u>Manufacturer's Blower Data</u>	<input style="width: 100%; height: 20px;" type="text"/>	
External Static Pressure (ESP).....	<input style="width: 50px;" type="text"/> IWC	<input style="width: 100%; height: 20px;" type="text"/>
High Speed.....	<input style="width: 50px;" type="text"/> cfm	<input style="width: 100%; height: 20px;" type="text"/>
Medium-high Speed.....	<input style="width: 50px;" type="text"/> cfm	<input style="width: 100%; height: 20px;" type="text"/>

**Figure 10. Pressure worksheet**



## 4.2 Room-by-Room Supply Requirements

Using the heating and cooling load room-by-room estimates, the volume of conditioned air needed to satisfy the load of each room must be calculated. Software packages will perform this task for the designer, but it is important to understand what parameters influence the values. ACCA Manual D (Rutkowski 2009) describes a two-step method for determining the room cubic feet per minute based on the equipment’s design blower capacity and the heating or cooling load. First a heating factor (HF) or cooling factor (CF) is determined by dividing the design blower cubic feet per minute of the equipment by the total heating or cooling load. The HF or CF value is then multiplied by the room load to determine the heating or cooling cubic feet per minute required to meet the room load.

$$\text{HF (or CF)} = \text{Design Blower Cubic Feet per Minute} \div \text{Total Heating (or Cooling) Load}$$

ACCA Manual D procedures select the highest airflow for each room and rely on seasonal adjustments of the balancing dampers to achieve the seasonal airflows. In an energy efficient house where ducts are in conditioned space, access to balancing dampers may not be possible. In addition to the potential for balancing dampers to not be accessible in concealed ductwork, this strategy relies on the occupant making the adjustments at least twice a year. Where balancing dampers cannot be avoided by careful duct sizing to airflows, the placement of the damper near the boot for fine tuning will help avoid accessibility issues.

Table 2 shows the room-by-room loads with the corresponding cubic-feet-per-minute requirements. The design cubic-feet-per-minute values used are the average values between the heating and cooling requirements. The Orlando House floor plan in Figure 11 shows how rooms such as the family room and the kitchen and nook can be combined based on their proximity and the performance characteristics of the ceiling supply outlet chosen.

**Table 2. Orlando House Room-by-Room Loads**

Room	Peak Heating Load		Peak Cooling Load		Actual Supply Airflows	
	Btu/h	cfm	Btu/h	cfm	Heating	Cooling
Family	4,459	132	4,055	137	193	193
Kitchen/Nook	2,094	62	1,628	55	0	0
Master Closet	0	0	0	0	0	0
Master Bath	1,250	37	858	29	33	33
Bath 2	0	0	0	0	0	0
Master Bedroom	3,614	107	3,049	103	105	105
Bedroom 2	1,655	49	2,013	68	59	59
Bedroom 3	1,723	51	2,101	71	61	61
Laundry	405	12	444	15	13	13
Bedroom 4	1,013	30	770	26	28	28
Living/Dining	4,256	126	3,907	132	129	129
Hallway	0	0	0	0	0	0
Bedroom 5	3,175	94	1,865	63	79	79
<b>TOTALS</b>	<b>23,644</b>	<b>700</b>	<b>20,689</b>	<b>700</b>	<b>700</b>	<b>700</b>

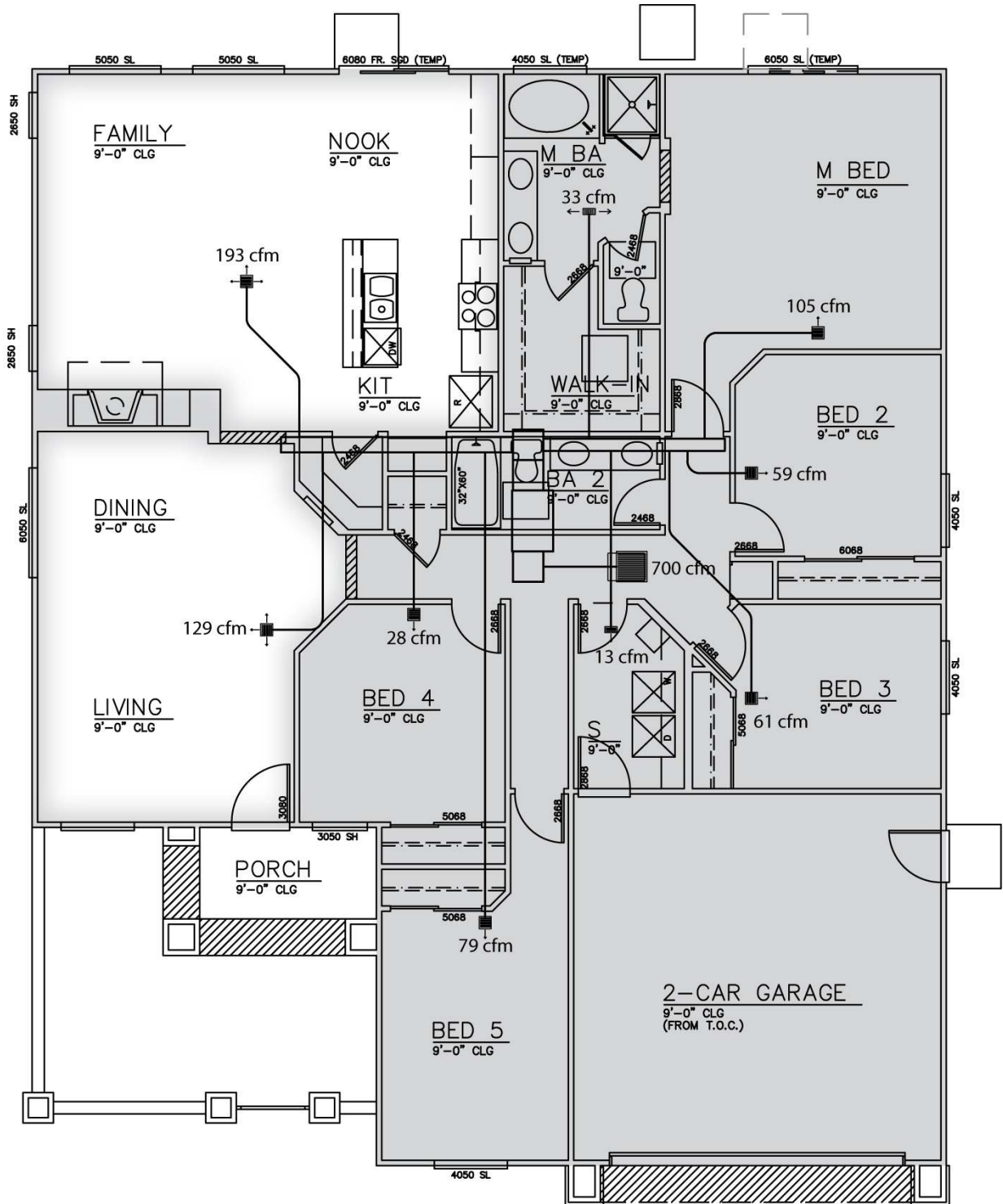
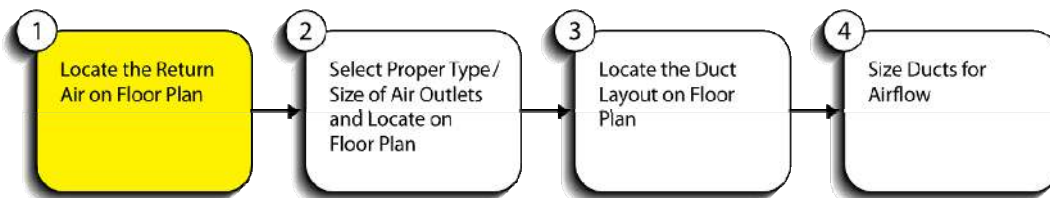


Figure 11. Orlando House floor plan

### 4.3 Return Air Design

A well-designed return air strategy is critical for the performance of the HVAC system in an energy efficient house with lower airflow requirements to meet the load (see Figure 12). The return air must “see” a clear path from every room that has a supply outlet, with the exception of bathrooms or kitchens due to the potential for spreading odors through the house.

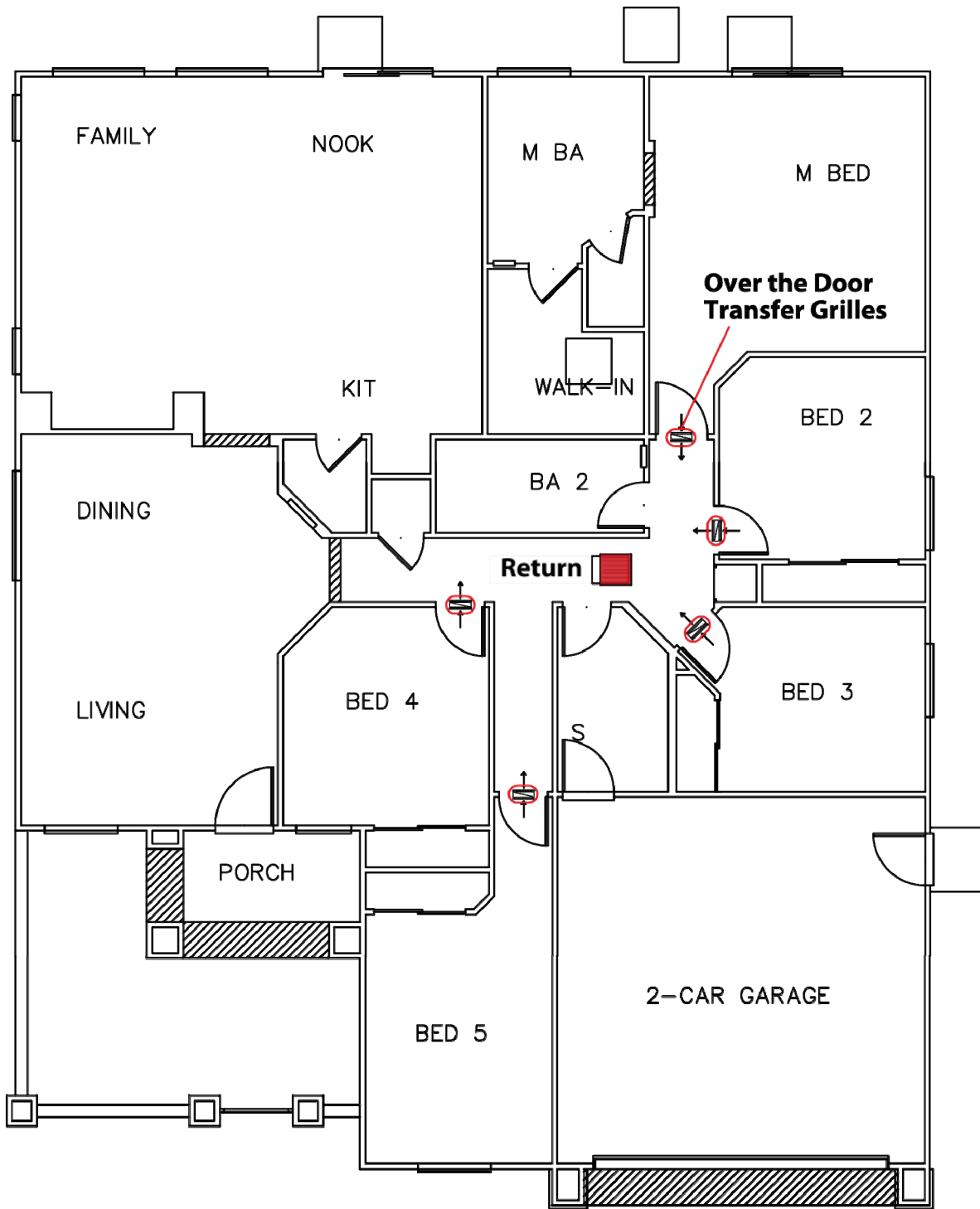
A direct return from each room to the equipment is not desirable when trying to minimize duct lengths and pressure losses in the return system. Rooms without an adequate return air path will become pressurized, which will impede supply airflow and could result in comfort complaints. Typical door undercuts (1/2 to 3/4 inch) do not allow adequate return volume and are not appropriate for an energy efficient house. Door undercuts are specifically not approved in ACCA Manual D (Rutkowski 2009).



**Figure 12. Locate the return first**

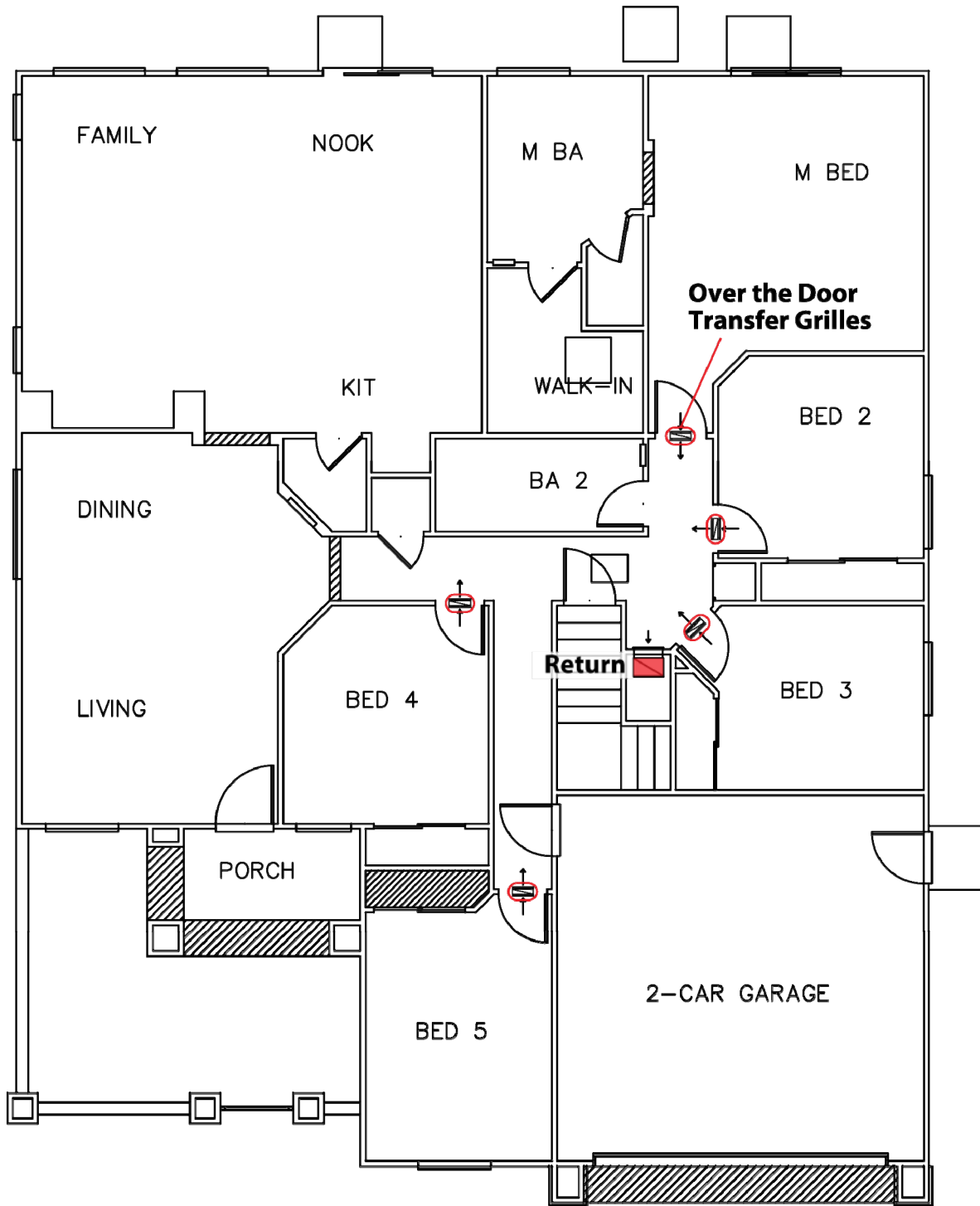
A low resistance in the return air path is defined as having less than 0.05 inch water column (iwc) pressure loss. The pressure loss for a filter at the return grille must also be considered in the return air stream. A target value for return capacity is two times the volume of the total supply air with an airflow velocity within the return at less than 500 feet per minute and the net free area of the grille sized 1.5 times the cross-sectional area of the return duct.

Utilizing a central return strategy is a simple and effective way to get air back to the air handler. In locating a central return, it should be placed in a central hallway where it is adjacent to the main living space of the house. Figure 13 shows the location of the central return in the ceiling of the Orlando House plan. Each room that has a door to close it off from the central space with the exception of the laundry and the hall bath utilizes an over-the-door transfer as a clear path from that room back to the central return.



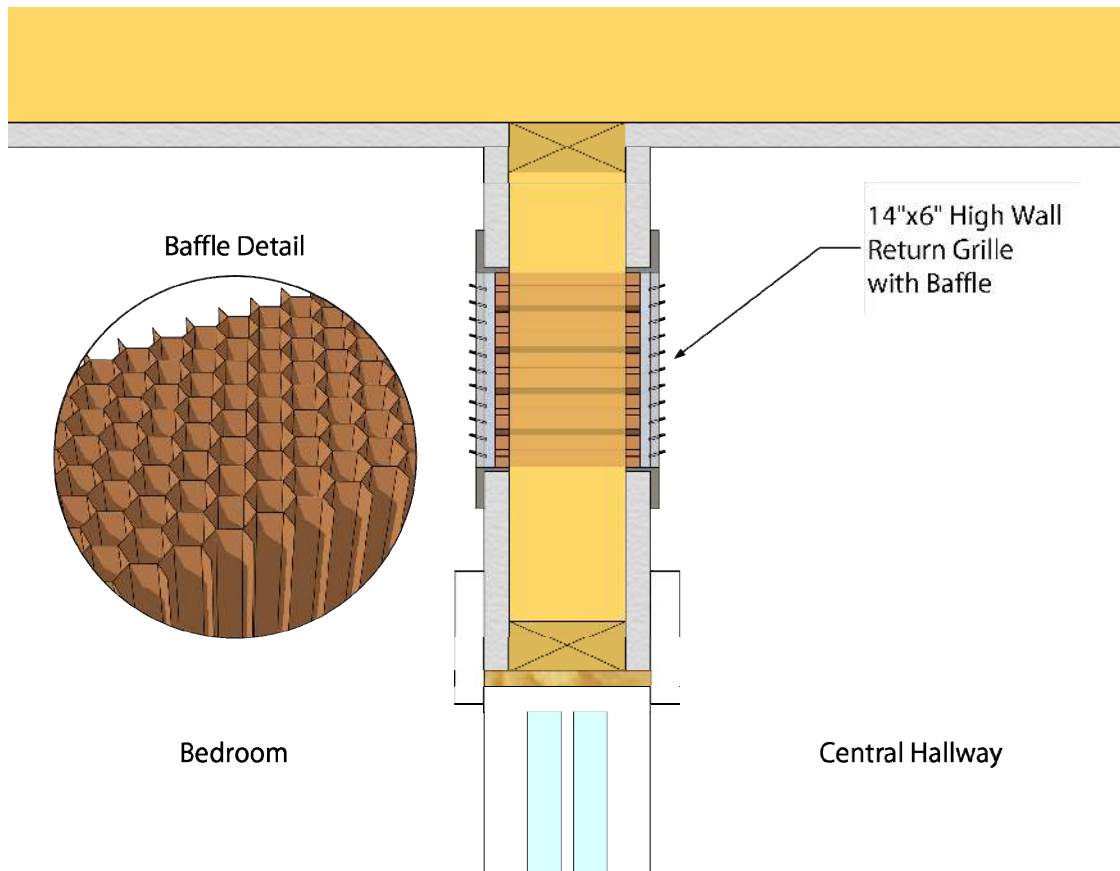
**Figure 13. Orlando House return location**

Figure 14 of the Chicago House plan shows a similar central return strategy except with a high sidewall return grille in a chase leading to the basement where the equipment is located.



**Figure 14. Chicago House return location**

An over-the-door transfer as shown in Figure 15, a high/low through-the-wall transfer as shown in Figure 16, or an attic transfer duct as shown in Figure 17 with adequate net free area are all appropriate solutions to provide a return air path without compromising privacy in the room.



**Figure 15. Over-the-door transfer**

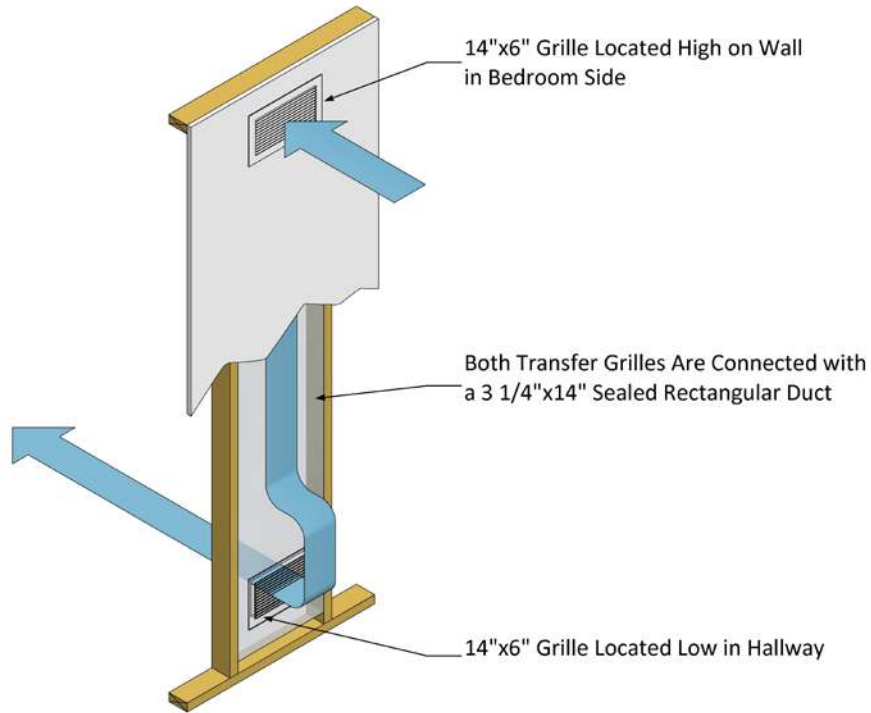


Figure 16. High/low through-the-wall transfer grille

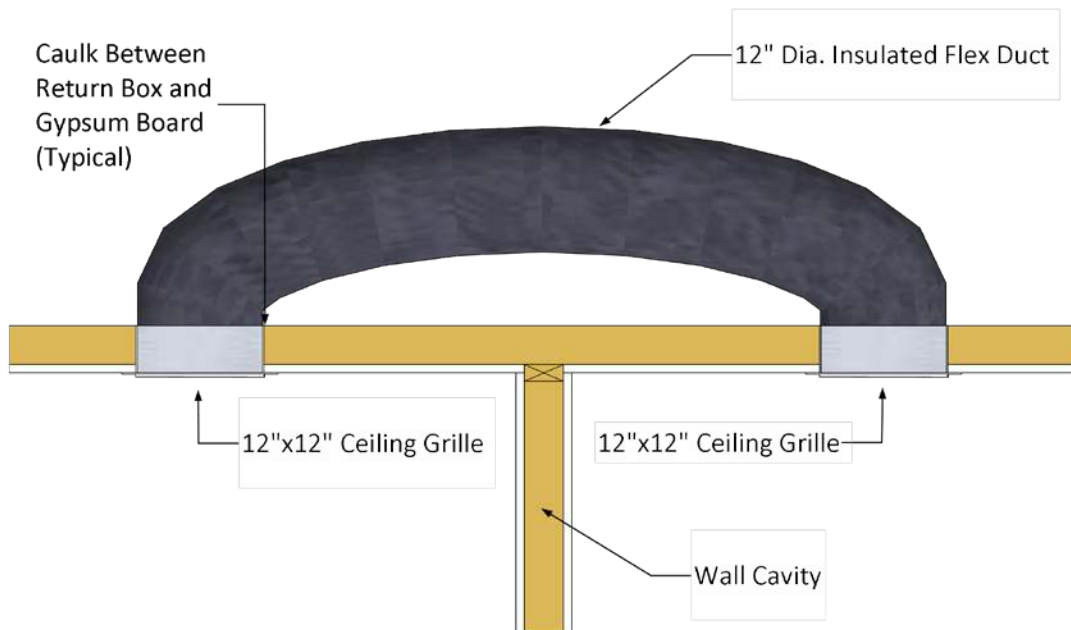
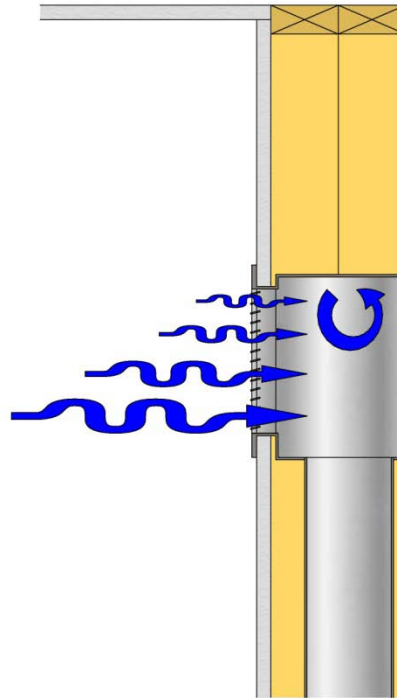


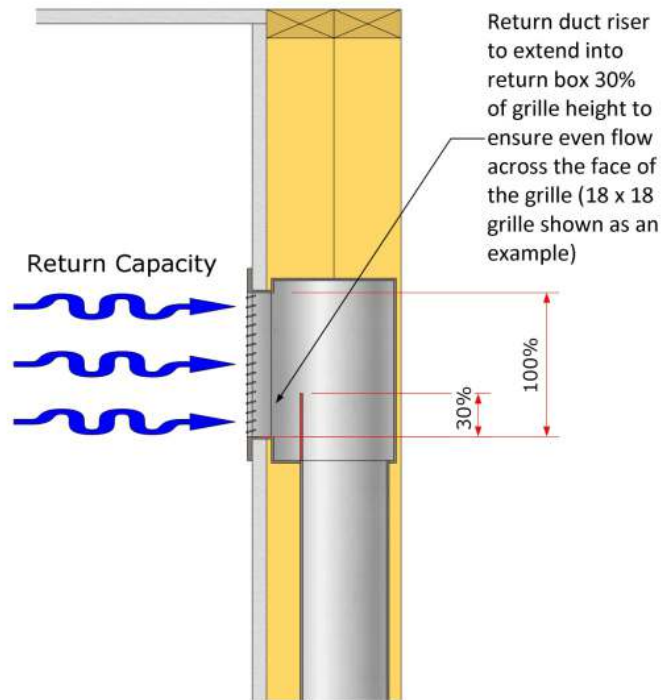
Figure 17. Attic transfer duct

Even with the proper net free area and sizing of the return duct, airflow can be restricted by turbulent air at the entrance of the return duct, causing poor performance and noise issues. In the example shown in Figure 18, the bottom of the return grille is flush with the top of the duct. This scenario will create turbulence at the back of the duct entrance that limits flow into the top of the grille, reducing the total return flow. By extending the return riser up one-third the area of the return grille as shown in Figure 19, the airflow within the riser is smoothed out, allowing for better flow back to the equipment.



**Figure 18. Poor return grille placement**

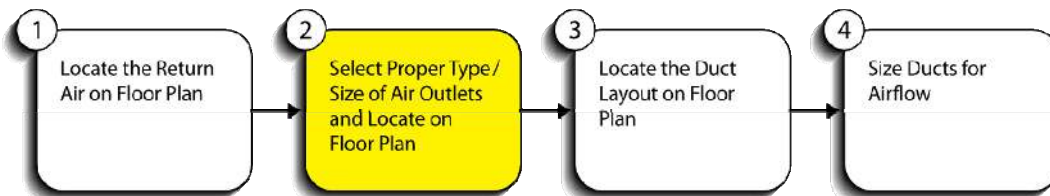




**Figure 19. Good design, high return**

#### 4.4 Supply Air Outlets

The selection and placement of the supply air outlets are critical to the comfort in the space (see Figure 20). The air must be delivered in a manner that mixes the supply air with the room air without introducing unacceptable noise or causing the sensation of a draft on the occupant. The manner in which the air is distributed in the room is the function of the shape and size of the air outlet. Placement of the air outlet is as important to the comfort in the room as is the type of air outlet that is selected.



**Figure 20. Select and size air outlets**

Historically, due to poor performing windows and lack of wall insulation, supply outlets were located at the perimeter of the house to “wash” the thermal enclosure with conditioned air. In an energy efficient house, rooms can be adequately conditioned from high sidewall or ceiling registers located toward the interior of the house, with the airflow directed toward the exterior walls. Floor registers at the perimeter should not be used because they are susceptible to being covered or blocked by furniture, making them completely ineffective. A room with only a single

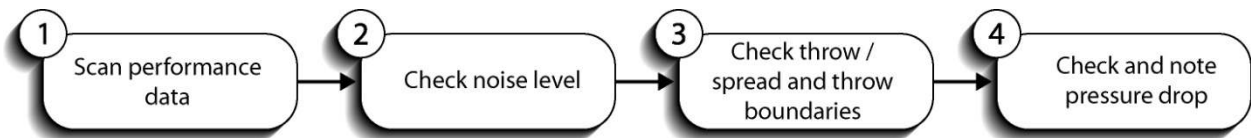
supply outlet that has been blocked by furnishings can be uncomfortable to an occupant. Where a floor register is unavoidable, it must be sized to the lower airflows of an energy efficient house.

A distribution strategy for the lower airflows required to meet the lower loads of an energy efficient house includes locating supply ducts on the interior walls and using more efficient outlets that throw the air to the exterior walls. This allows for better mixing with the room air. Ducts and supply outlets should be sized for the following purposes:

- Maintain the air velocity as high as possible without creating noise problems.
- Promote mixing of the air in the room.
- Limit stratification.

The strategy utilized for the Chicago House is a high sidewall throwing outlet, while the Orlando House uses a curved blade ceiling outlet. Both strategies direct the air outward across the room and high above the occupants' heads, where the air can mix with the room air to deliver the desired comfort.

There are four general steps to selecting the proper air outlet, as shown in Figure 21. Although it may appear that these steps are sequential, steps 1, 2, and 3 are iterative and may need to be performed several times before the correct supply outlet is selected. The designer must continually strike a balance between desired throw characteristics and pressure drop during the air distribution design process.

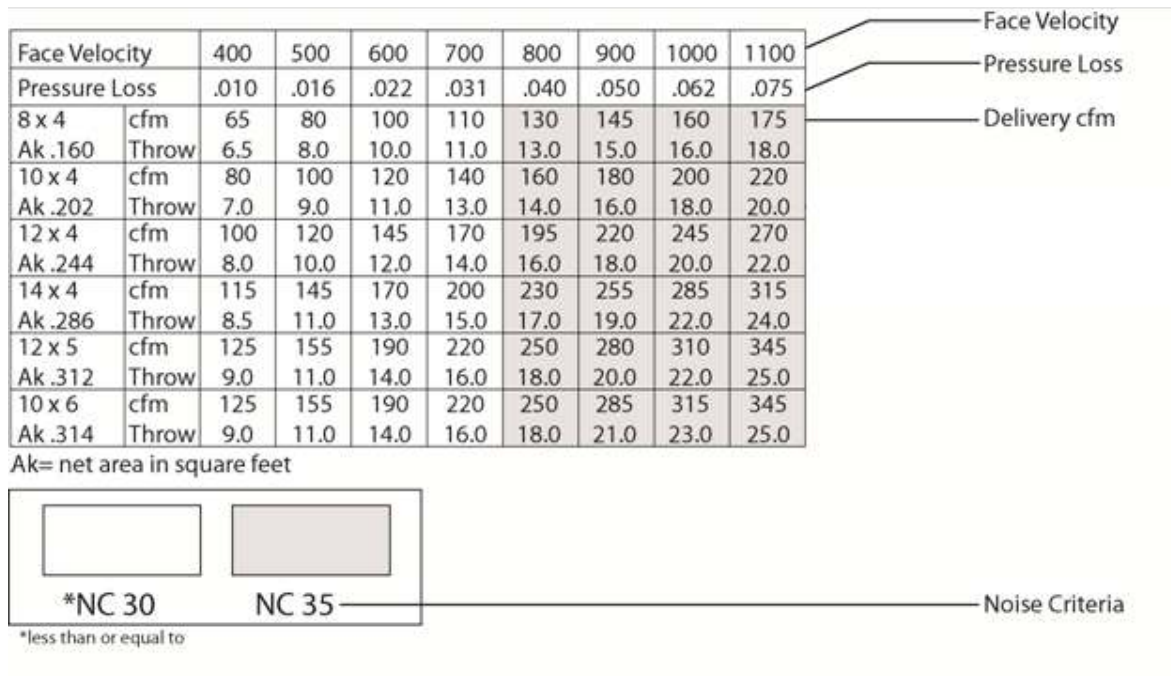


**Figure 21. Air supply outlet selection**

The required cubic feet per minute for the room being serviced by the supply outlet is a critical input to the selection process as well as the face velocity, throw, spread, pressure loss, mounting location, and NC.

The target face velocity for the high performance strategy is between 700 and 900 feet per minute. For the high performance strategy with a high interior sidewall outlet, the ideal scenario would be a throw that just reaches the opposing exterior wall at a terminal velocity of 75 feet per minute or has a throw that is 2 feet greater than the distance to the wall at a terminal velocity of 50 feet per minute.

The performance data for a register are published by the manufacturer in a data table such as the one shown in Figure 22.

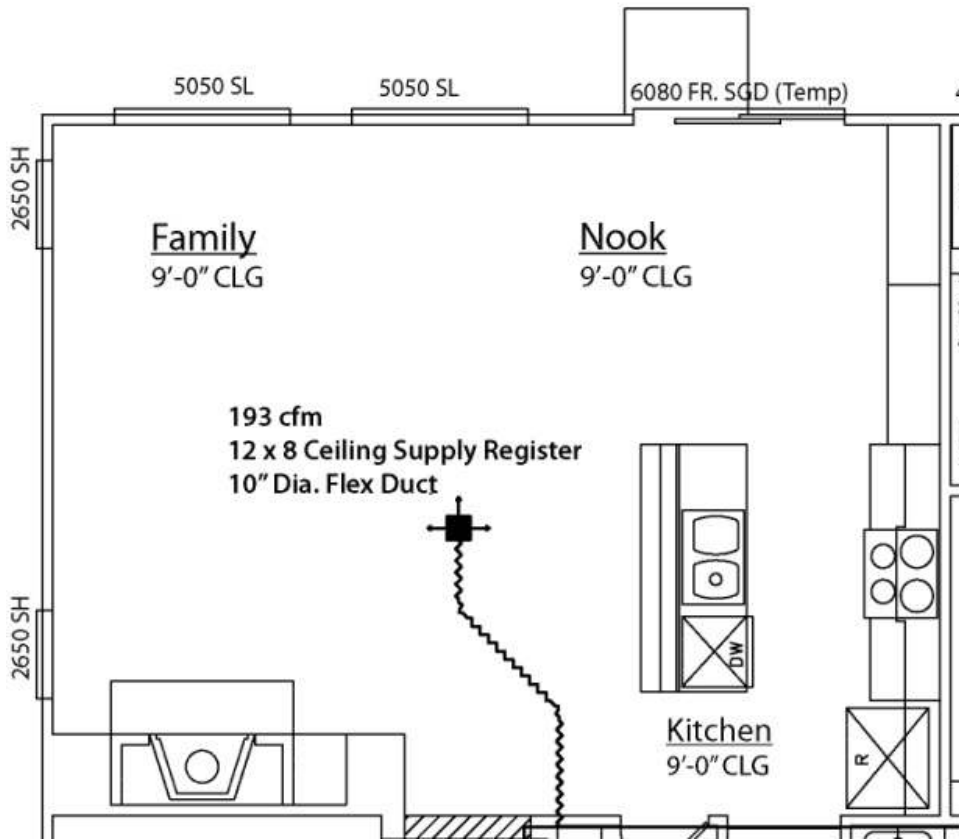


**Figure 22. Example supply outlet performance data**

The performance data are often published at a terminal velocity value of 75 to 100 feet per minute. If the listed throw at the 75-feet-per-minute terminal velocity is the throw necessary for the room, then these data are acceptable; however, it is likely that it will be necessary to interpolate the throw distance at 50 feet per minute. The procedures for doing these calculations are best handled using the calculations for non-isothermal jets as described in the *ASHRAE 2009 Handbook—Fundamentals* (ASHRAE 2009b).”

Other considerations that are not directly performance related but should be considered are availability, price, material, and appearance. Availability of low-cost high sidewall or ceiling supply outlets to satisfactorily meet the low air volumes of an energy efficient house with good throw characteristics can present a challenge in design. More options are becoming available in manufacturers’ residential lines, but it may be necessary to search light commercial options to find appropriate outlets with the desired performance characteristics.

The additional costs of a higher performing curved blade ceiling outlet or high sidewall outlet can often be offset by a reduction in the number of outlets and the associated ductwork. The Orlando House family room and kitchen and nook area as shown in Figure 23 would require three or four typical residential supply outlets run to the exterior walls in a traditional design, whereas in this example, one three-way curved blade outlet in the center of the room supplies the necessary airflow.



**Figure 23. Orlando House family room and kitchen and nook area**

The same space in the Chicago House is serviced by a pair of one-way throw high sidewall supply outlets on interior walls aimed toward the exterior wall (see Figure 24). Selecting an outlet with adjustable blades will allow for the air to be directed into the room, avoiding a collision mid-room and the potential for the sensation of a draft.

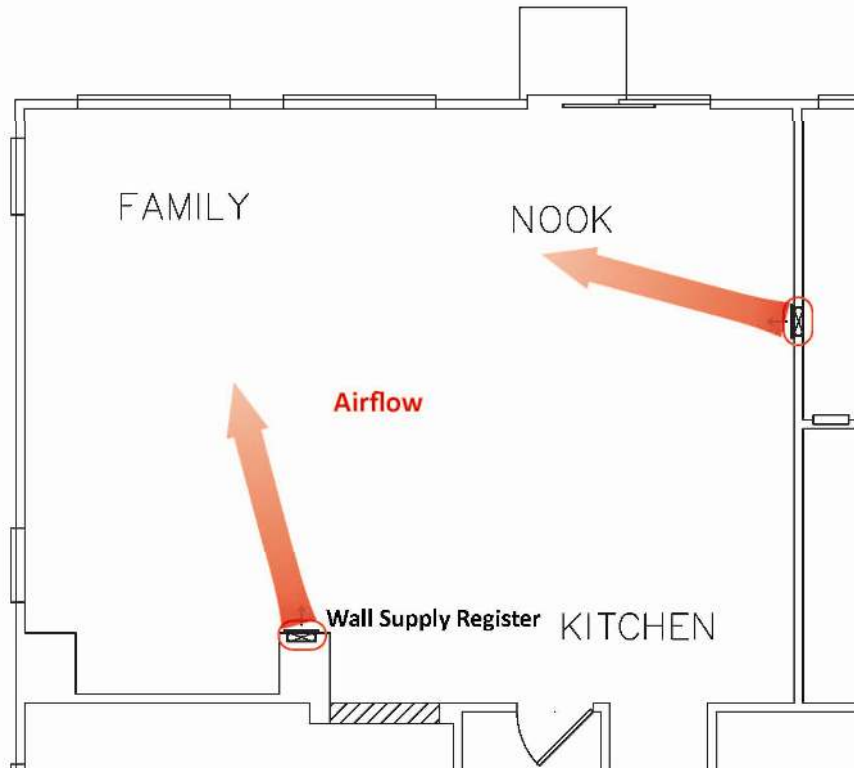


Figure 24. Chicago House family room and kitchen and nook area

### 4.5 Duct Layout

From the early integrated design work and the room-by-room airflows, a preliminary layout of the ductwork can be completed on the floor plans (see Figure 25). Figure 26 shows the layout and cubic-feet-per-minute requirements as well as the outlet locations and types for the Orlando House. A combination of one-way, two-way, and three-way ceiling supply outlets is used, along with insulated flexible duct.

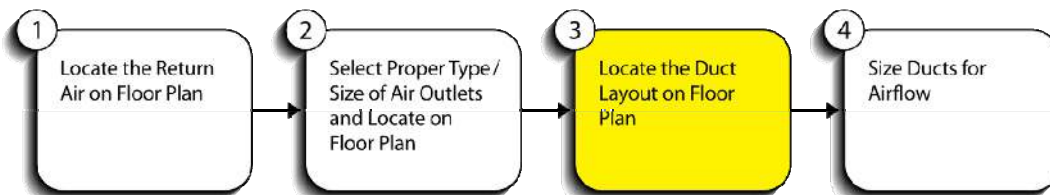
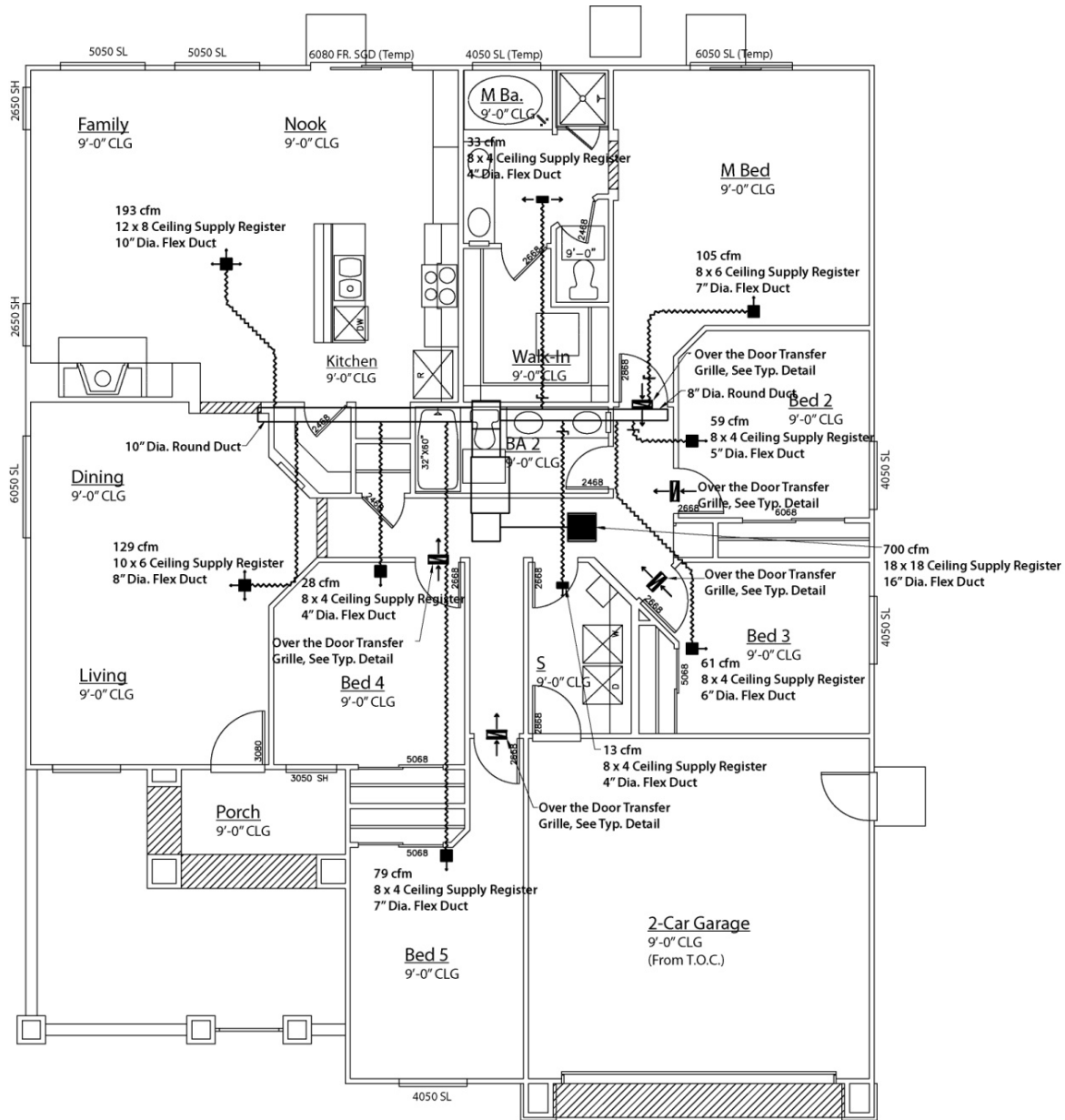


Figure 25. Duct layout



**Figure 26. Orlando House layout**

The Chicago House as shown in Figure 27 uses oval wall stacks and all galvanized steel ducts to bring the air up from the basement to the high sidewall supply outlet locations. Care is taken to avoid bringing ductwork out of the conditioned space and into the attic. The basement with the equipment and duct location is shown in Figure 28. Two supplies and one return service the unfinished basement area.

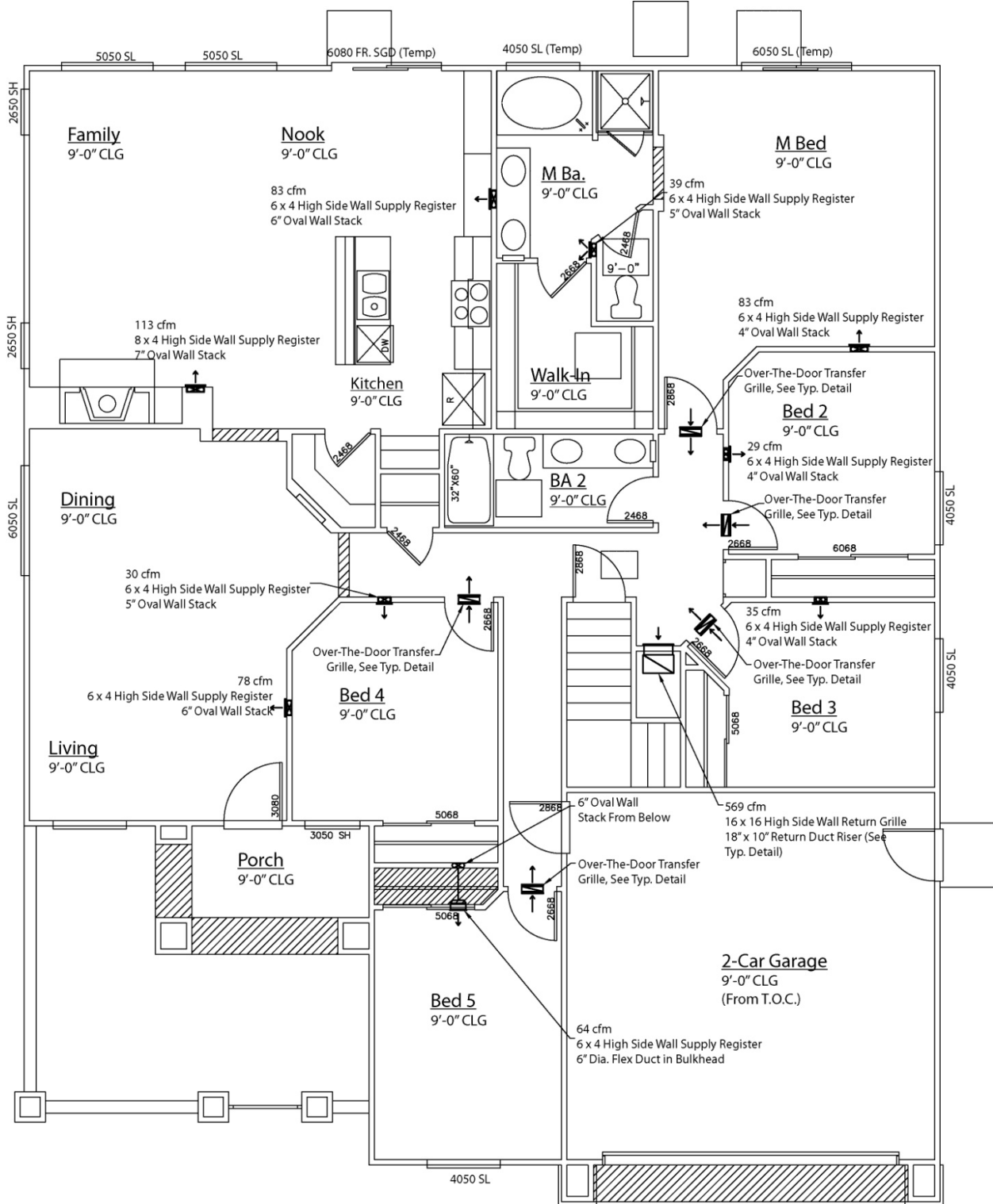
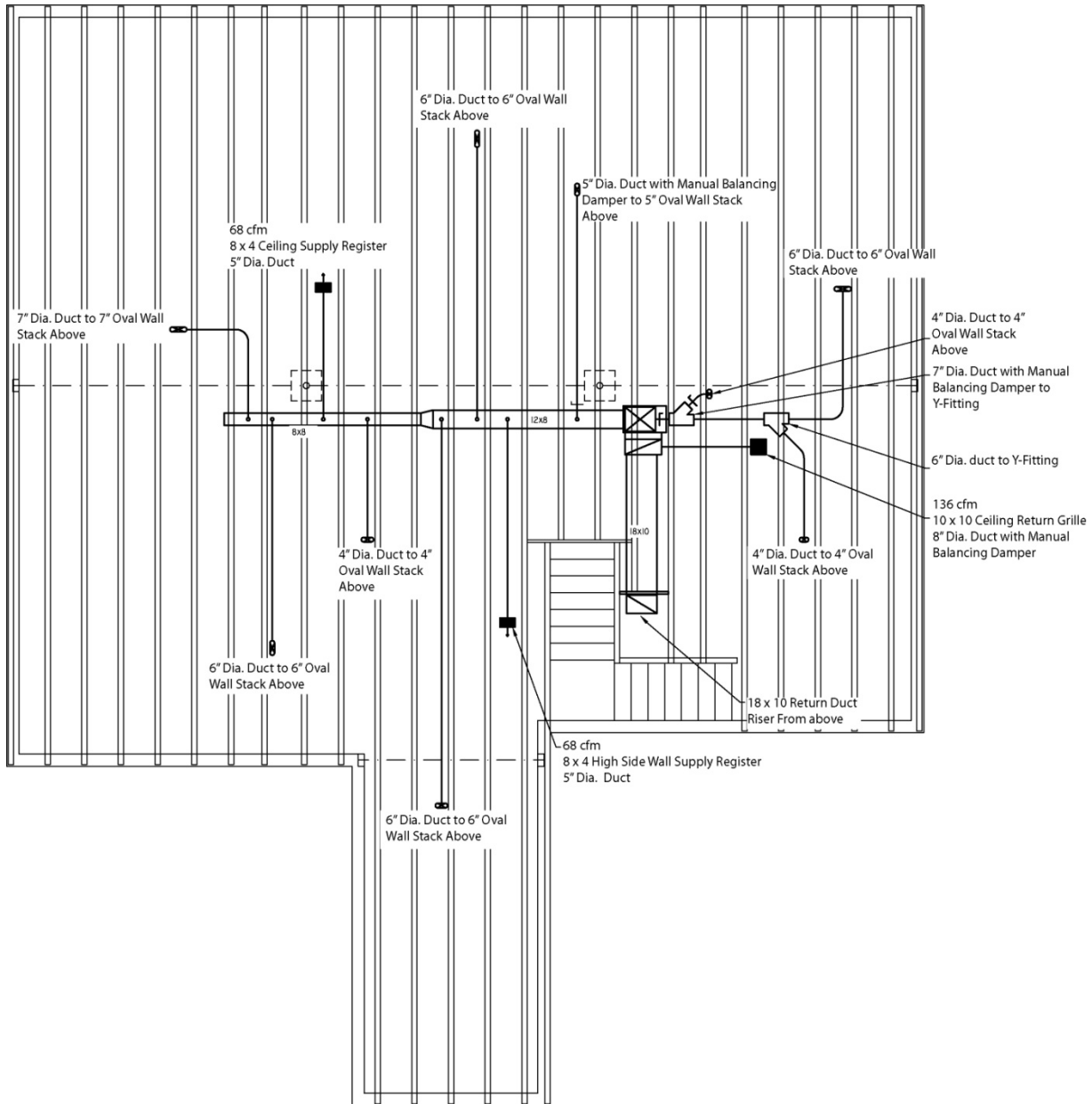


Figure 27. Chicago House main floor

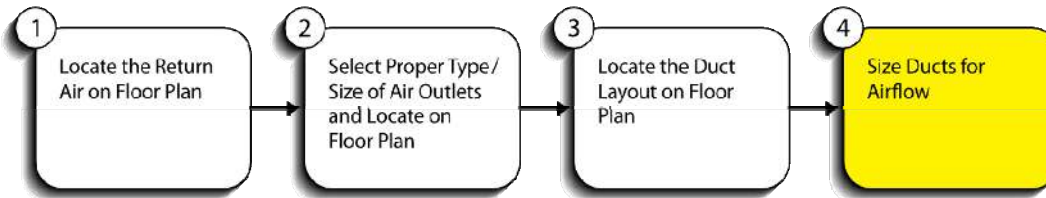


**Figure 28. Chicago House basement layout**

#### 4.6 Duct Size

The duct size is selected relative to the amount of air that must pass through the ductwork (see Figure 29). The variables that define the performance of the duct airflow are the cubic feet per minute of air into the room based on the heating and cooling loads, the friction loss in the duct, the cross-sectional area of the duct, and the average velocity of the air moving in the duct.





**Figure 29. Size ducts for airflow**

ACCA Manual D procedures calculate the friction rate based on the worst case or “critical path” duct run that has the longest effective length (Rutkowski 2009). The critical path friction rate is then used for the design of all other duct runs, even though the actual friction rate may be lower. This method slightly oversizes ducts with shorter runs, and the ACCA Manual D standard of care requires the use of balancing dampers in every duct run to adjust the airflow to each room.

ACCA Manual D acknowledges that in an energy efficient house where ducts are in conditioned space, access to balancing dampers may not be possible; therefore, dampers cannot be installed. The ACCA Manual D standard of care neither endorses nor condemns the practice of designing duct sizes based on the individual friction rate and flow and only offers caution regarding the complexity of this design method and the potential for inadequate performance if noise criteria are ignored.

**Friction rate** – The pressure loss between two points in a duct system that are separated by a specific length. The units for friction rate are inches water column per 100 feet (iwc/100 ft).

**Effective length** – The length of duct used for design purposes that includes the straight length of duct added to all the fitting equivalent lengths.

**Equivalent length** – The amount of duct length added to a duct run by fittings. Often the equivalent length of a fitting can be equal to or longer than the straight duct lengths due to the additional friction of turning air.

The *ASHRAE 2009 Handbook—Fundamentals* (ASHRAE 2009a) describes the procedures to evaluate the friction rate at each duct run and then to size the duct accordingly to achieve a “self-balancing” system. Calculating the friction rate of each duct in an effort to accurately select the correct duct for a balanced system without dampers does require more rigorous calculations because most commercial software is based on the ACCA duct design methodology. In most cases, averaging the airflows between the heating and cooling requirements for self-balancing systems is a reasonable compromise. However, where there is a larger disparity in the loads, the designer should evaluate the room-by-room loads and may want to favor a heating or cooling airflow for rooms with unique conditions, such as sunrooms, rooms over garages, and rooms with significantly longer runs than most others.

The calculations for a self-balancing system will be more complex. The size of duct calculated may be non-standard, requiring careful design consideration in choosing the next larger or smaller standard size. Also, close attention must be given to avoid excessive velocity in smaller ducts. Duct performance is defined by the following four independent variables:

- Duct diameter
- Flow rate (cubic feet per minute)
- Velocity
- Friction rate.

To manage all of the variables and calculations of the ASHRAE method, the use of a spreadsheet for calculations is critical. Table 3 shows how the pressure losses in each supply run are tracked based on a duct velocity of 427 feet per minute, standard duct diameters, the required cubic feet per minute per room, the roughness factor of galvanized steel, and the effective length of the duct with fittings included.

**Table 3. Chicago House Supply Pressure Loss**

Duct Run	Room	Take-off Dia. (in.)	Duct Length Dia. (in.)	Branch (cfm)	Duct Length Material	Effective Length	Pressure Loss
1	Family	7	7	113	Galvanized Steel	99	0.070
2	Living/Dining	6	6	78	Galvanized Steel	92	0.067
3	Basement Rear	5	5	68	Galvanized Steel	69	0.073
4	Bedroom 4	4	4	30	Galvanized Steel	68	0.054
5	Bedroom 5	6	6	64	Galvanized Steel	85	0.052
6	Kitchen/Nook	6	6	83	Galvanized Steel	80	0.068
7	Basement Front	5	5	68	Galvanized Steel	60	0.070
8	Master Bath	5	5	39	Galvanized Steel	66	0.037
9	Master Bedroom	6	6	83	Galvanized Steel	58	0.052
10	Bedroom 3	4	4	35	Galvanized Steel	49	0.049
11	Bedroom 2	4	4	29	Galvanized Steel	37	0.025
					Minimum	37	0.025
					Average	69	0.056
					Maximum	99	0.073

Default equivalent lengths are calculated based on the velocity of 900 feet per minute. As an example, the effective length for the master bedroom is calculated for the design velocity of 427 feet per minute with the data shown in Table 4.

$$EL_x = EL * (V_x/V)^2$$

where

EL = effective length

V = velocity

**Table 4. Master Bedroom Duct Run**

Element	Equivalent Length	Adjusted Manual D Fitting EL	Manual D Fitting Number	Manual D Reverence Velocity	Diameter (in.)	Flow Rate (cfm)	Velocity (fpm)	Friction Rate (in./100 ft)	Pressure Loss (iwc)
Branch Take-off	50	20.0	2-P	900	8	149	427	0.045	0.00899773
Branch Length	31.25	31.3			8	149	427	0.073	0.02295476
Elbow	5	6.2	11	400	8	149	427	0.073	0.0045551
Diffuser Boot	60	23.9	4-Z	900	8	149	427	0.045	0.01079727
Subtotals		81.34779							0.047305

## 5 Conclusion

The higher performing house has a lower load, and consequently less air volume is needed to condition the space. This presents both challenges and opportunities when designing the air distribution system. Challenges arise when using air outlets sized by “rule of thumb” that do not have the throw needed to provide air mixing in the room to achieve the desired comfort results. At the same time, the energy efficient house design process offers opportunities to integrate the HVAC system into the design earlier in the process.

Early consideration of the HVAC system in the whole house design can lead to an efficient and comfortable house. Trying to force a system late in the design process may end up with undesirable consequences.

The equipment selected to meet the heating and cooling loads has a specific capacity of air delivery against a specific static pressure. Each component in the air distribution system has an associated pressure loss that must not exceed the available static pressure of the equipment.

Lower volumes of air must be delivered to the space in a manner that will provide good mixing with the space air to provide comfort. Careful consideration of the air outlet strategy and a full duct design are critical to the HVAC system delivering the comfort in an energy efficient house, whether it is new construction or an energy upgrade retrofit. Both system noise and noise at the air outlet are important comfort considerations in the air distribution system design.

The return air system to bring air back to the air handling equipment is critical to the comfort levels within the house. Because the return air ducts are typically much larger than the supply ducts, the placement of the return air system is to be considered early in the design process.

In the entire HVAC design process, heating and cooling loads are dependent on the construction and location of the house, while the equipment selection is dependent on the loads, and the air distribution system is dependent on both the loads and the equipment capacity. The success of a design in either flexible duct or rigid duct depends on the faithful execution of the design during installation. The ACCA/ANSI Standard 5 (ACCA 2010) has been established to ensure that quality installations occur.

## 6 References

ACCA. ACCA Standard 5 HVAC Quality Installation Specification. Arlington, VA: Air Conditioning Contractors of America. 2010.

Air Diffusion Council. ADC Flexible Duct Performance and Installation Standards, 5th Edition. Schaumburg, IL: Air Diffusion Council. 2010.

ASHRAE. *ASHRAE 2009 Handbook—Fundamentals*, Chapter 21, Duct Design. Atlanta, GA: American Society of Heating, Refrigerating and Air-Conditioning Engineers. 2009a.

ASHRAE. *ASHRAE 2009 Handbook—Fundamentals*, Chapter 20, Space Air Diffusion. Atlanta, GA: American Society of Heating, Refrigerating and Air-Conditioning Engineers. 2009b.

Burdick, A. (2011a). *Strategy Guideline: Accurate Heating and Cooling Load Calculations*. Washington, DC: U.S. Department of Energy. [www.nrel.gov/docs/fy11osti/51603.pdf](http://www.nrel.gov/docs/fy11osti/51603.pdf).

Burdick, A. (2011b). *Strategy Guideline: HVAC Equipment Sizing*. Washington, DC: U.S. Department of Energy. To be published in fall 2011.

Rutkowski, H. *Manual D—Residential Duct Systems*, 3rd Edition. Arlington, VA: Air Conditioning Contractors of America. 2009.

Rutkowski, H. *Manual J—Residential Load Calculation*, 8th Edition. Arlington, VA: Air Conditioning Contractors of America. 2006.

Rutkowski, H. *Manual S—Residential Equipment Selection*. Arlington, VA: Air Conditioning Contractors of America. 1995.

Rutkowski, H. *Manual T—Air Distribution Basics for Residential and Small Commercial Buildings*. Arlington, VA: Air Conditioning Contractors of America. 1992.

**EERE Information Center**

1-877-EERE-INFO (1-877-337-3463)

*[www.eere.energy.gov/informationcenter](http://www.eere.energy.gov/informationcenter)*

U.S. DEPARTMENT OF  
**ENERGY**

Energy Efficiency &  
Renewable Energy

DOE/GO-102011-3461 • December 2011

Printed with a renewable-source ink on paper containing at least 50% wastepaper, including 10% post-consumer waste.