

FOAMULAR® CodeBord® Air Barrier System

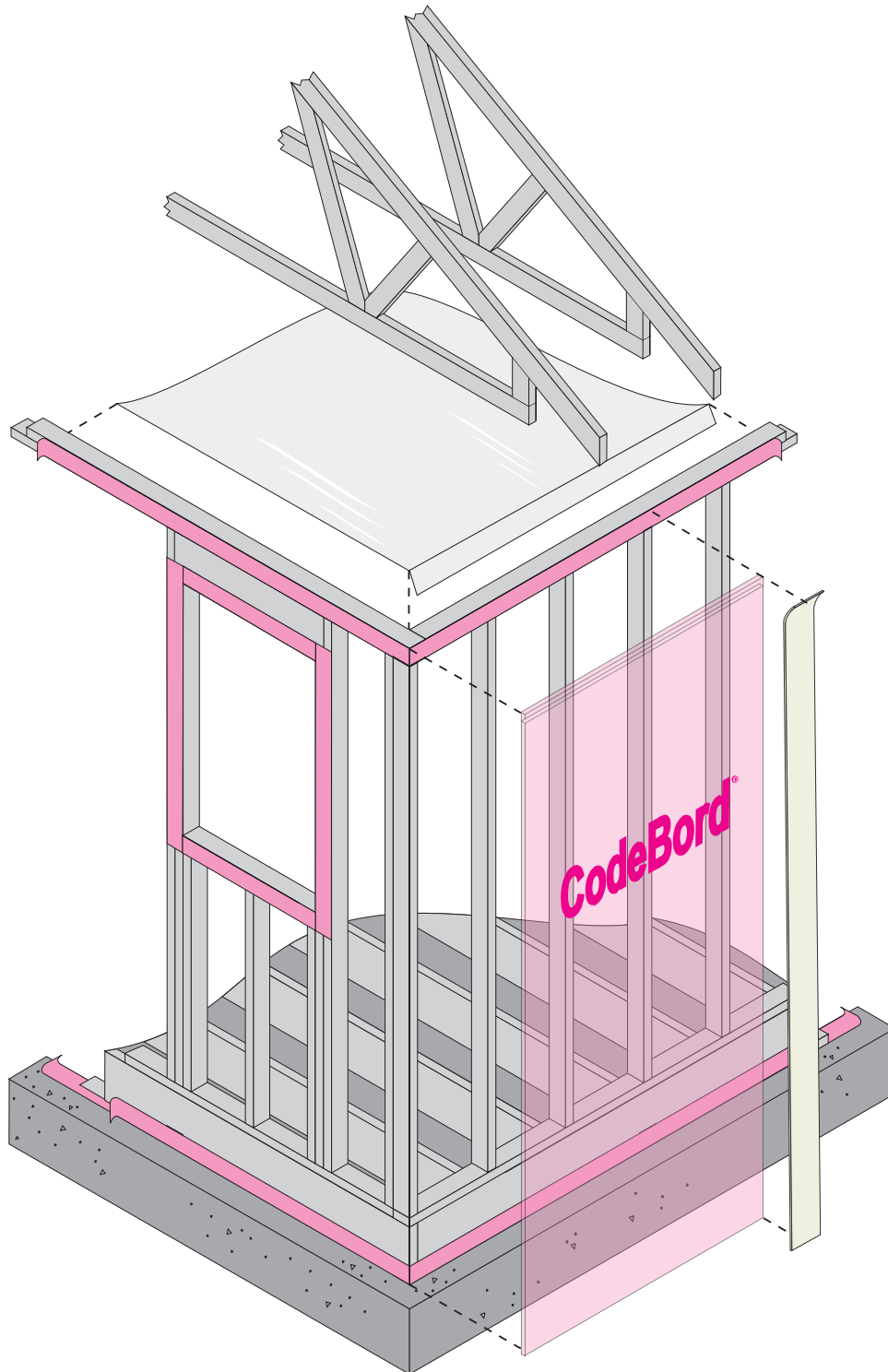

an illustrative guide

AB
B
B
B
X
E



INNOVATIONS FOR LIVING®

tools & equipment

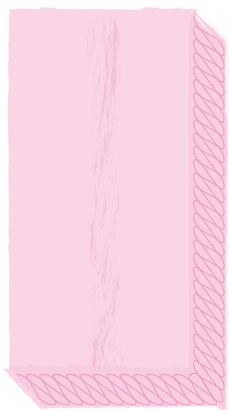

EcoTouch® PINK™
Fiberglas® Thermal
Batt Insulation
(R-12, R-14, R-20, R-22 or R-24)

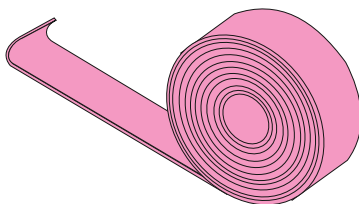

FoamSealR™
Polyethylene Gaskets
(3-1/2" or 5-1/2")

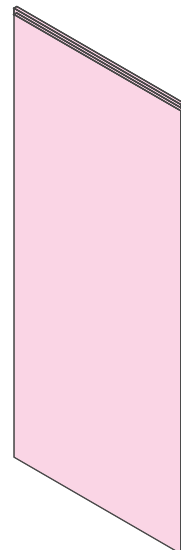

FOAMULAR® CodeBord®
Extruded Polystyrene Rigid
Insulation
(4'x8' or 4'x9') with shiplap edges

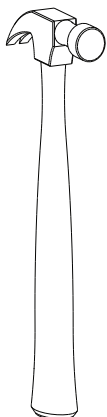

Hammer

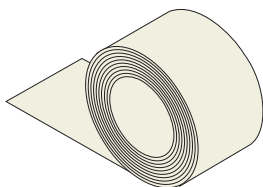

JointSealR™ Foam Joint Tape
(3.5" x 90') and FlashSealR™ Foam
Flashing Tape (4", 6", or 9" x 75')

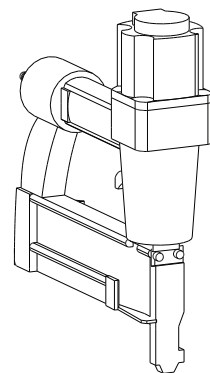

Nailer

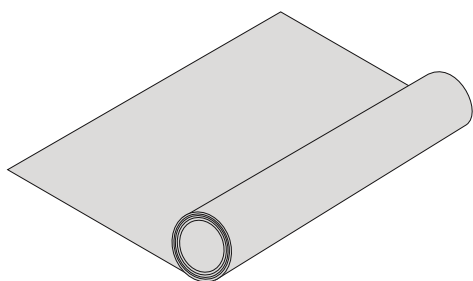

Polyethylene Vapour Barrier
(air barrier for ceiling application)

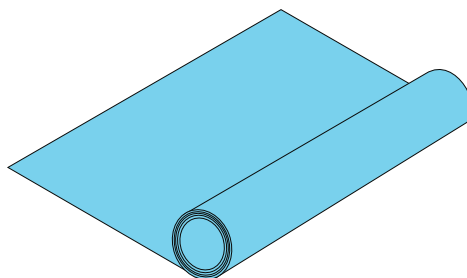

Header Wrap Air Barrier

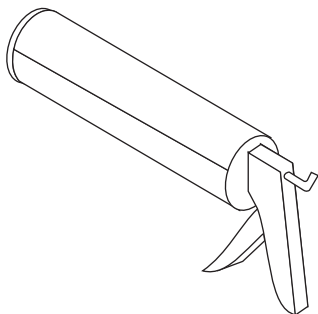

Caulking Sealant

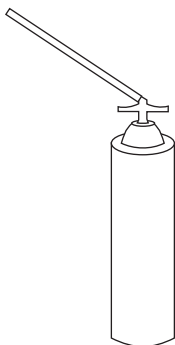

Owens Corning™
Foam Sealant
(12 oz. or 20 oz.)

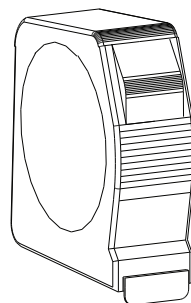

Tape Measure

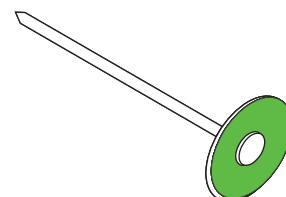

Nails with Plastic
or Metal Washers

1 Install gasket and mud sill

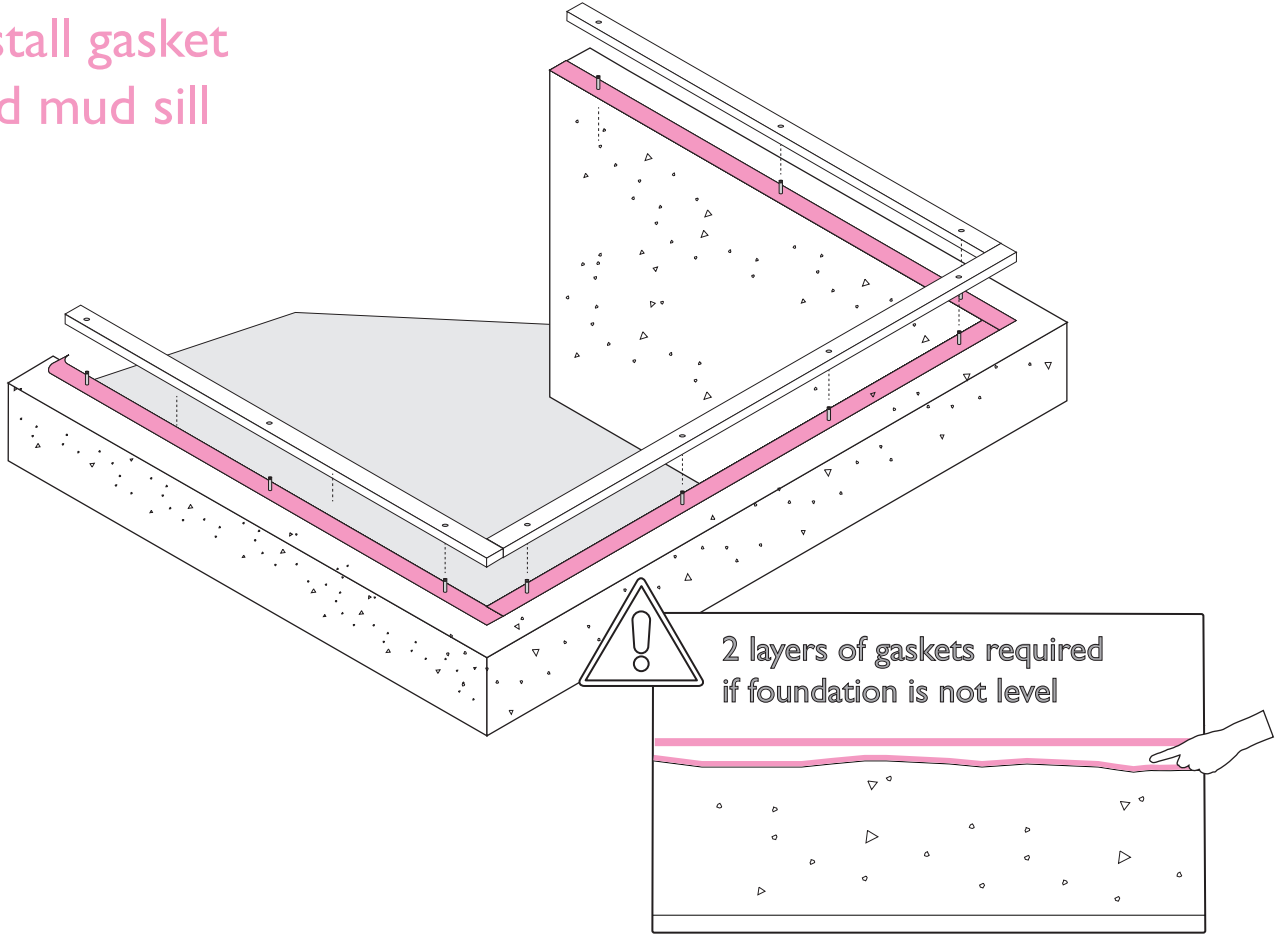

2 Install header and floor

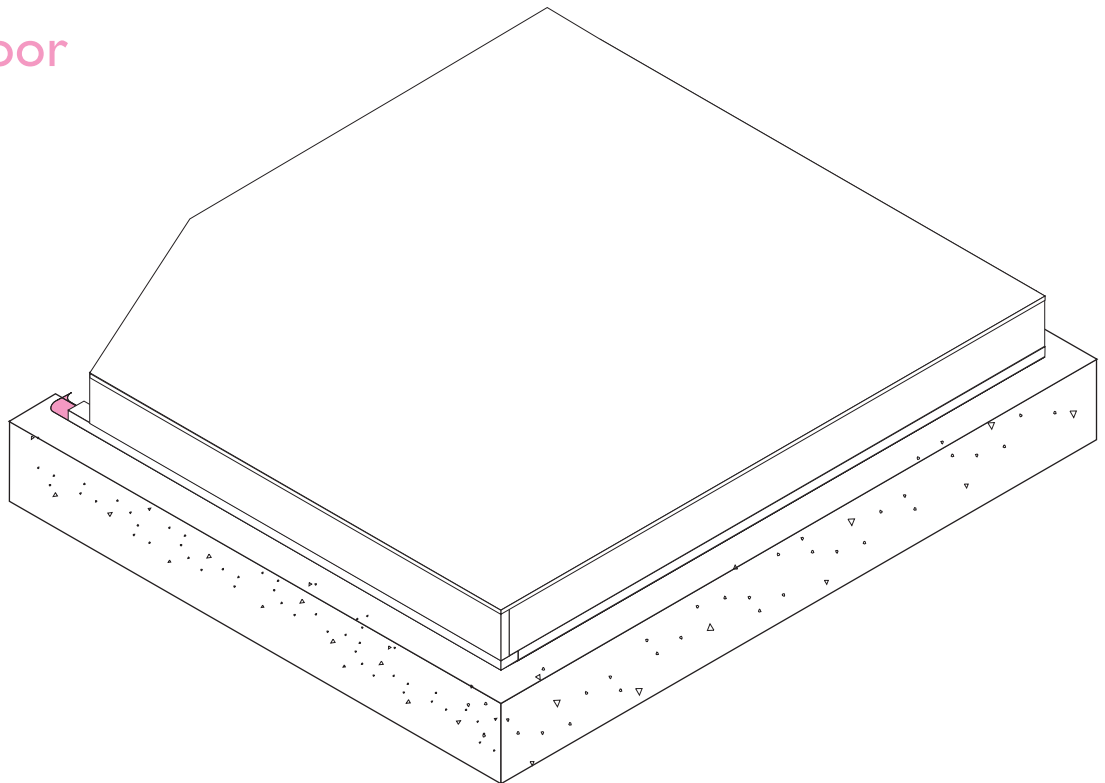

3 Frame the wall on the flat and install T-bracing

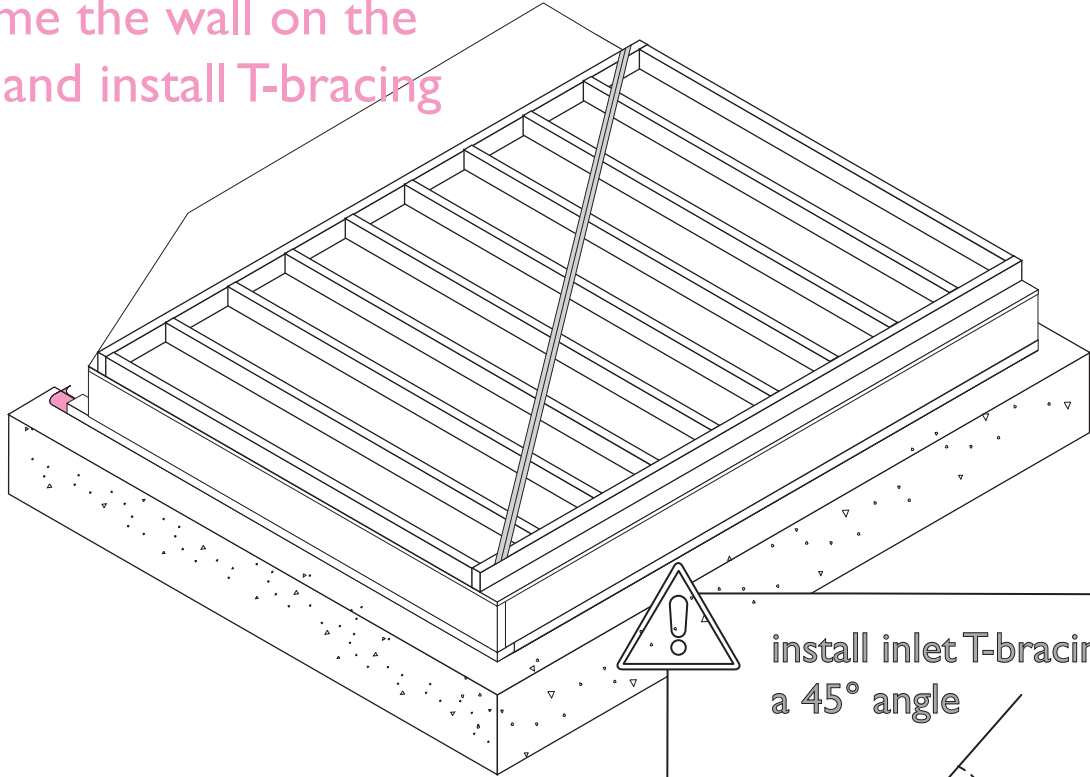

install inlet T-bracing at a 45° angle

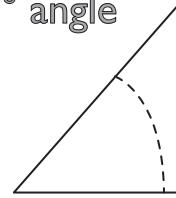

4 Place CodeBord® Insulation on wall

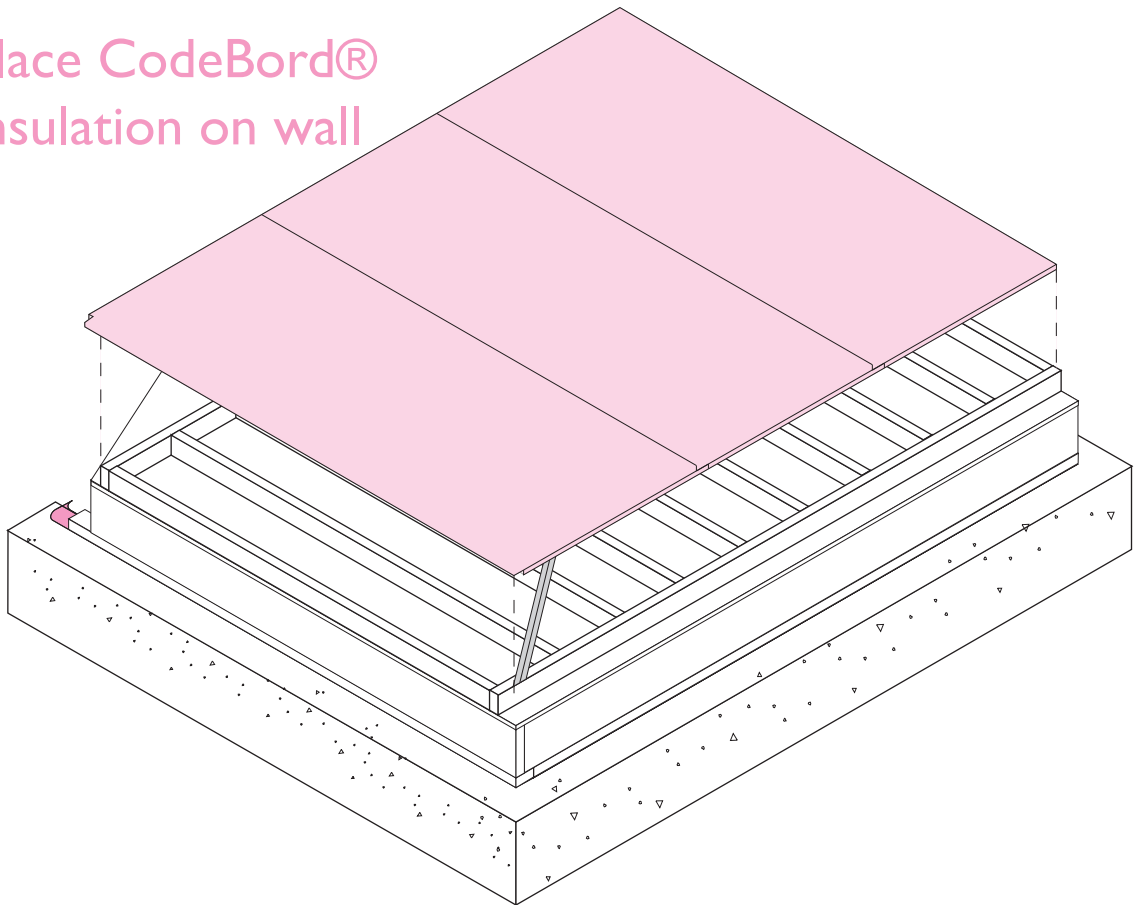

5 Nail CodeBord® Insulation to wall studs

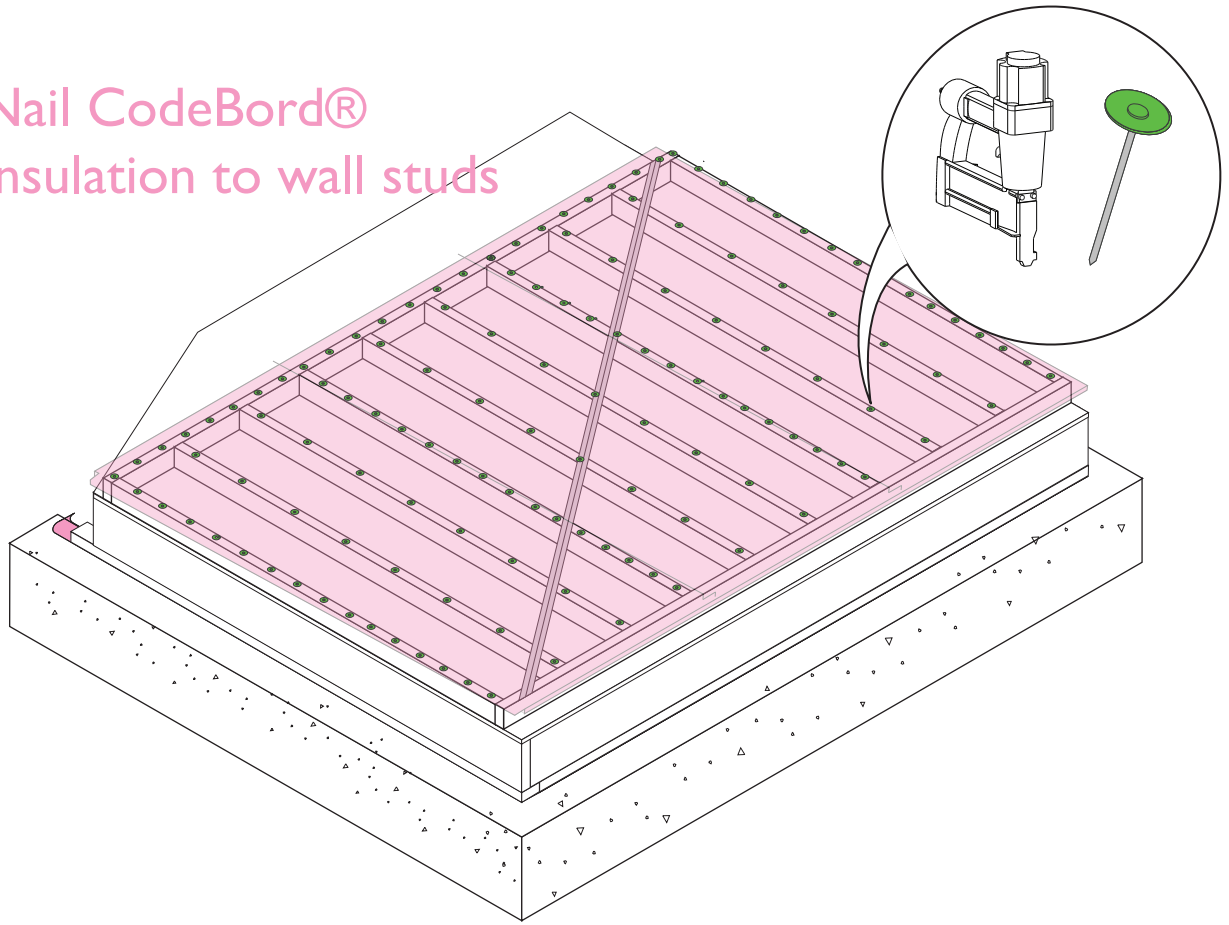

6 Tape all butt edges

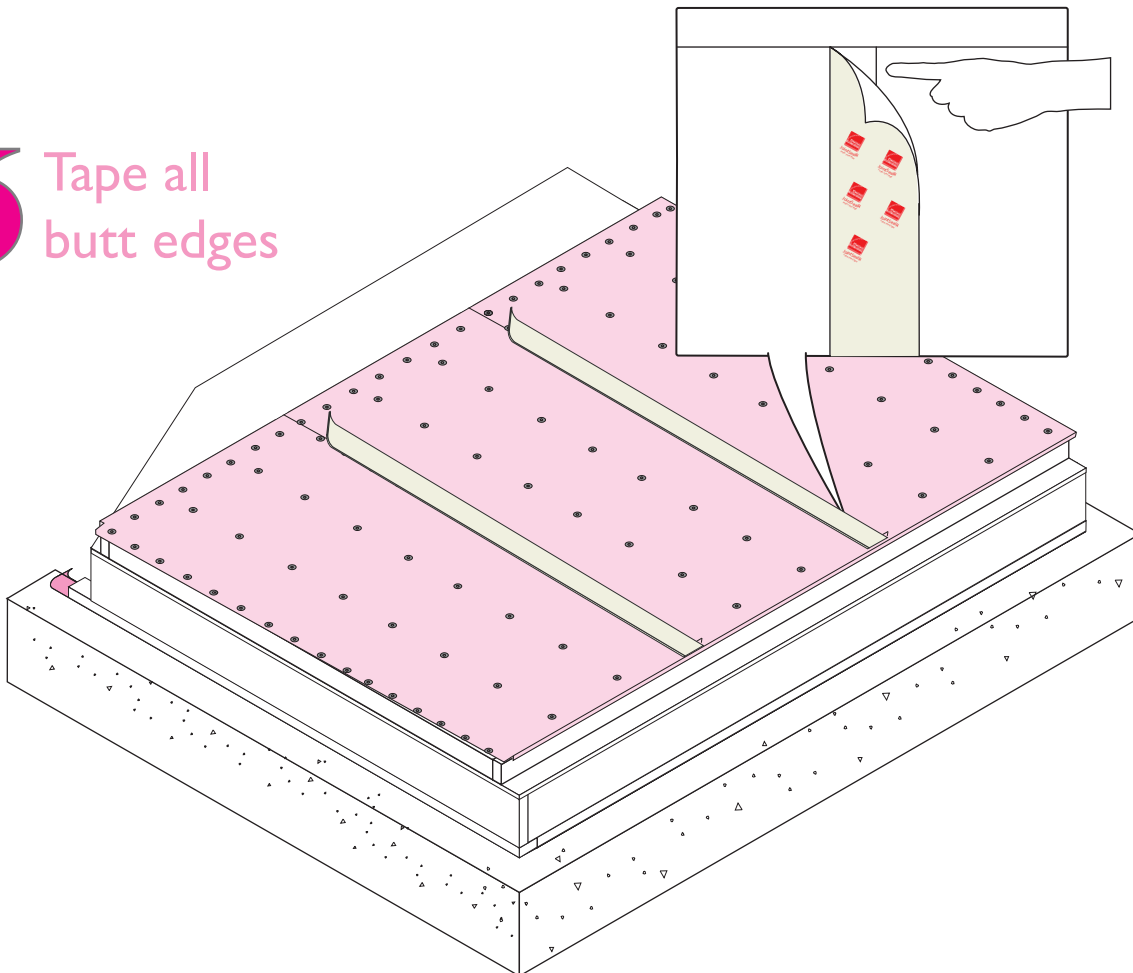

7 Install flashing

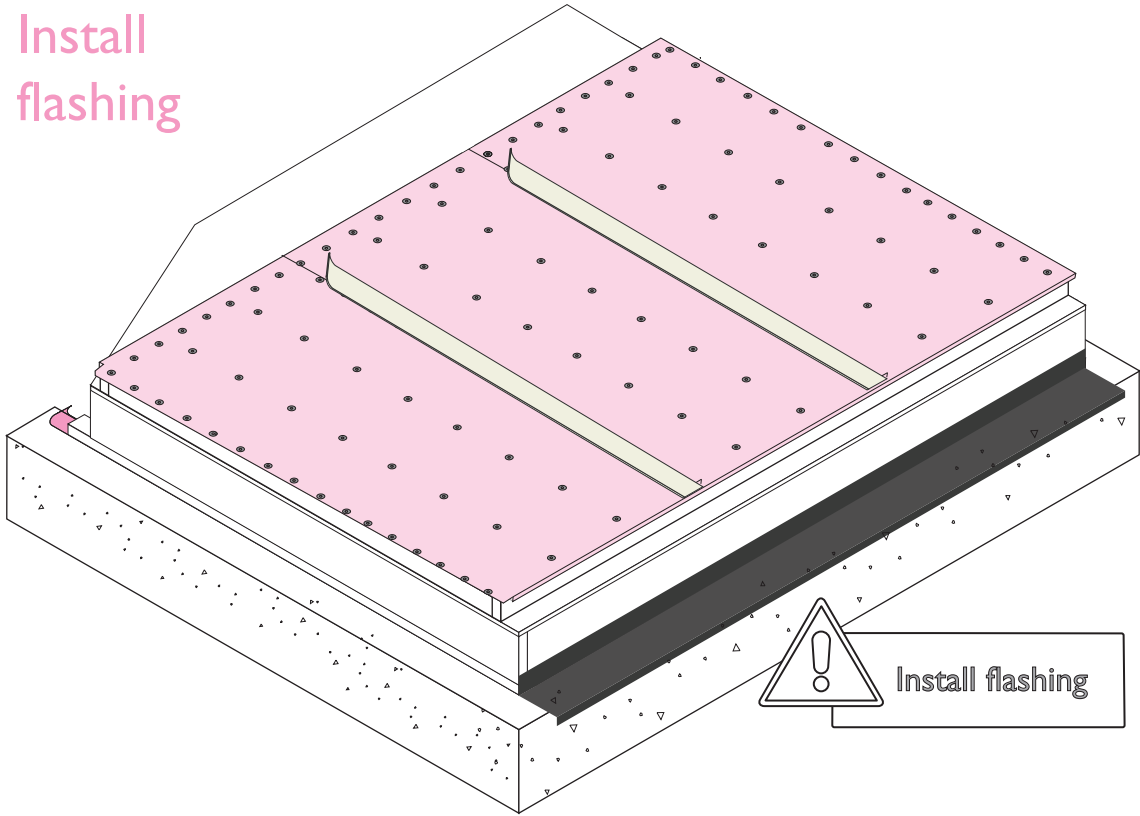

OPTIONAL: Install strapping

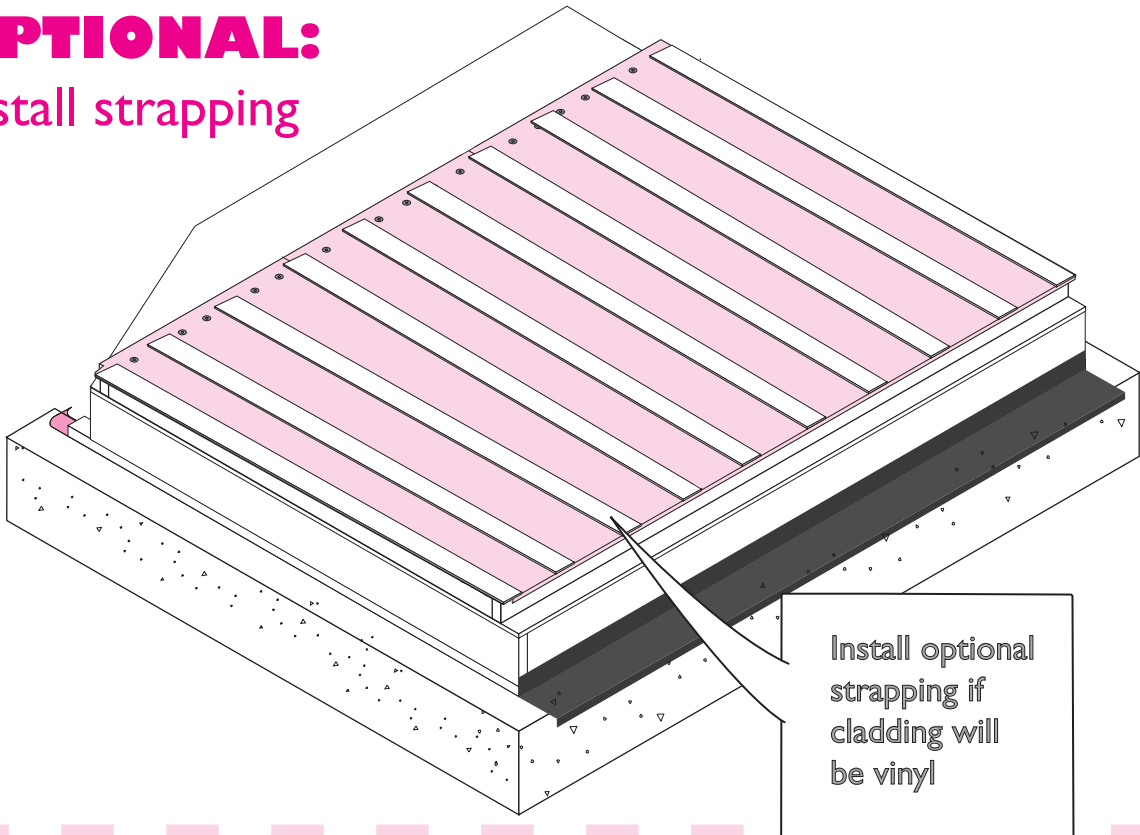

8 Install header gasket

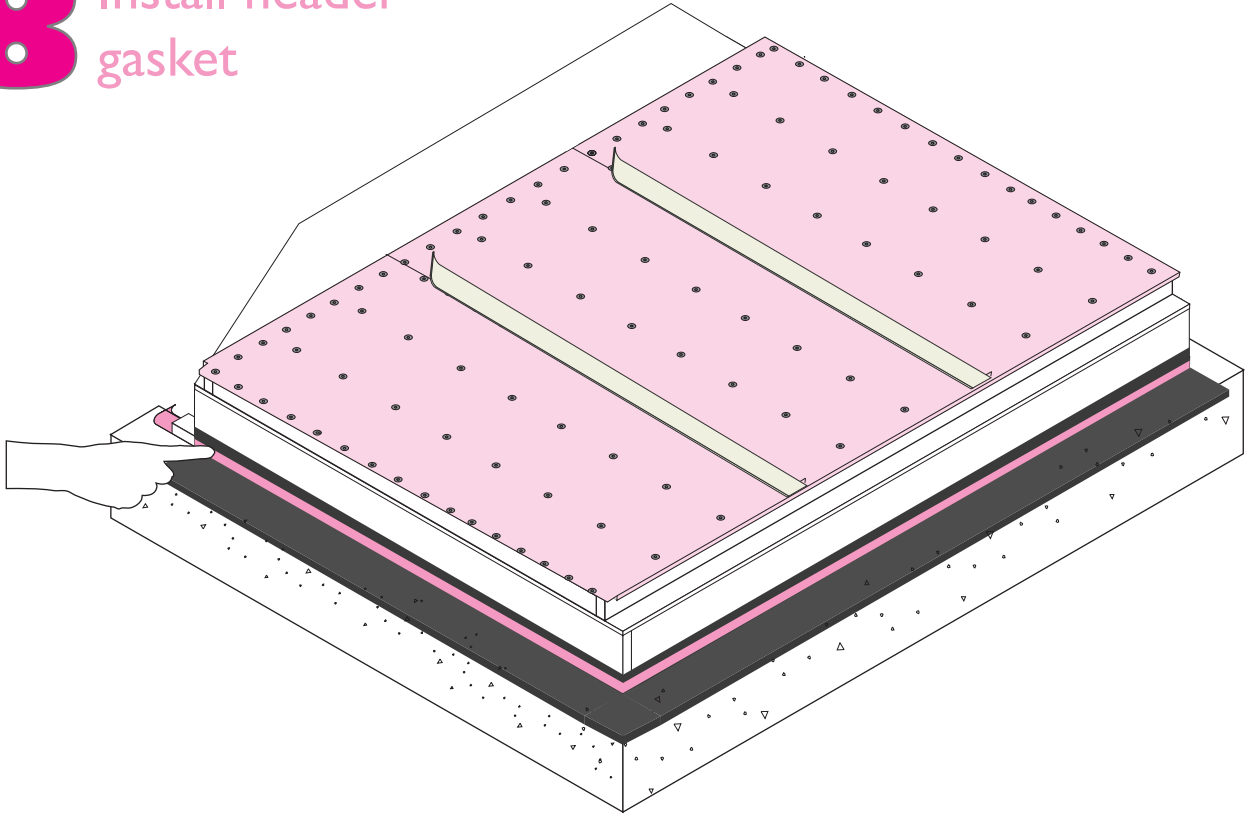

9 Stand-up the wall

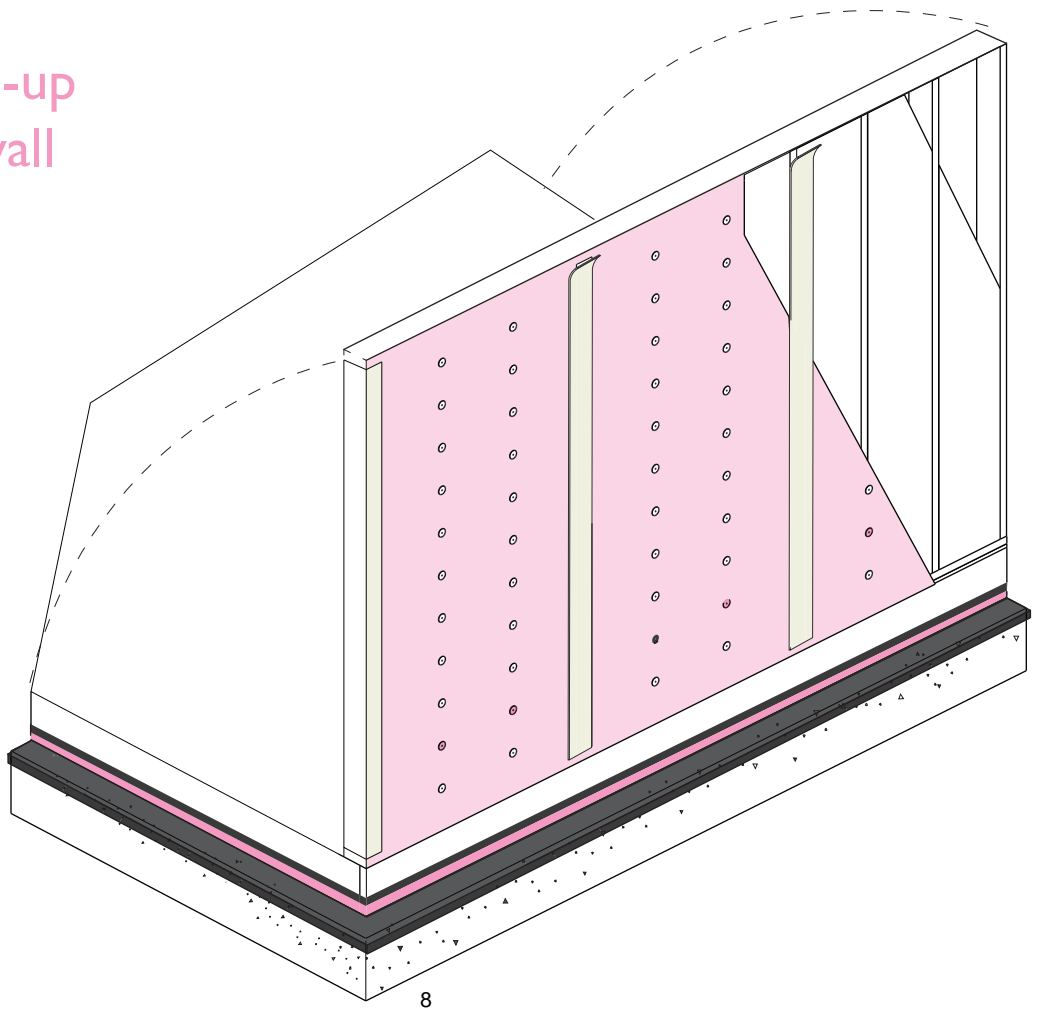

1 Header detail

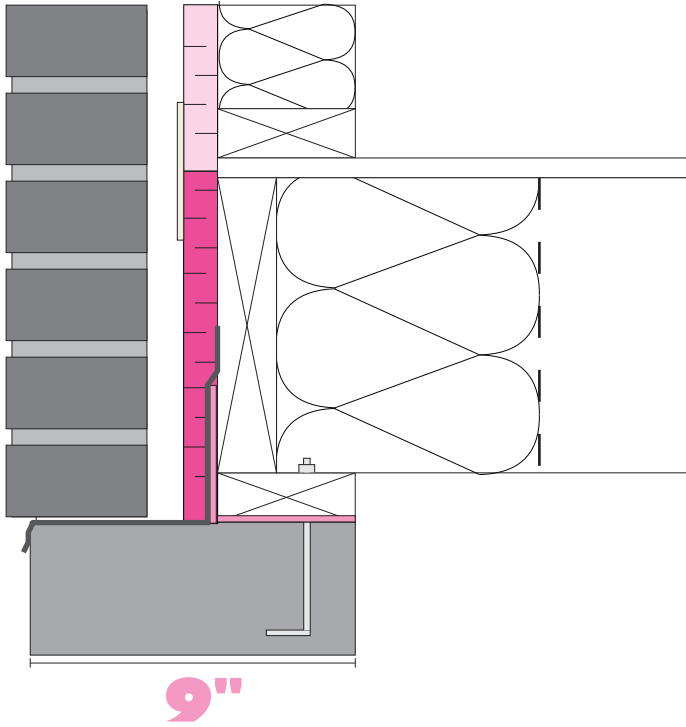

additional CodeBord®
Insulation piece over the
header is installed in Step 2!



BRICK

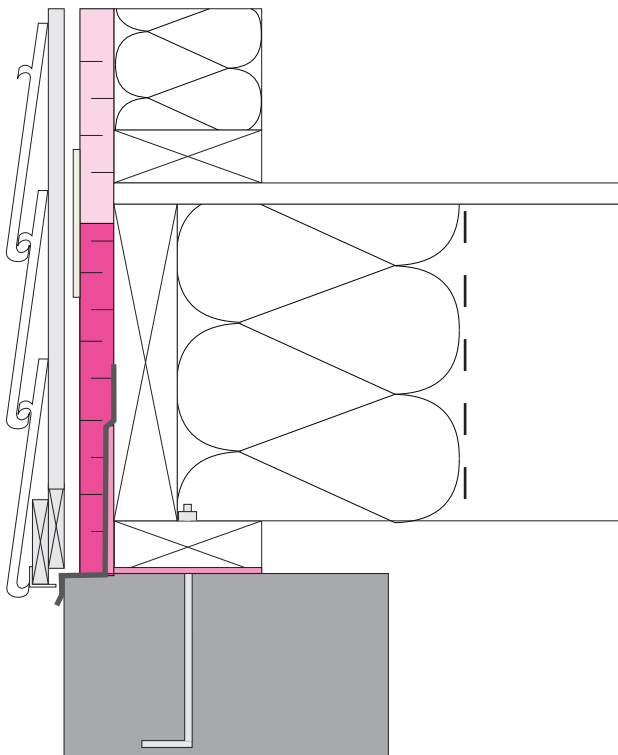

strapping is optional



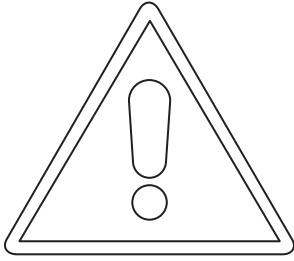

Alternative CodeBord® Insulation extends over header

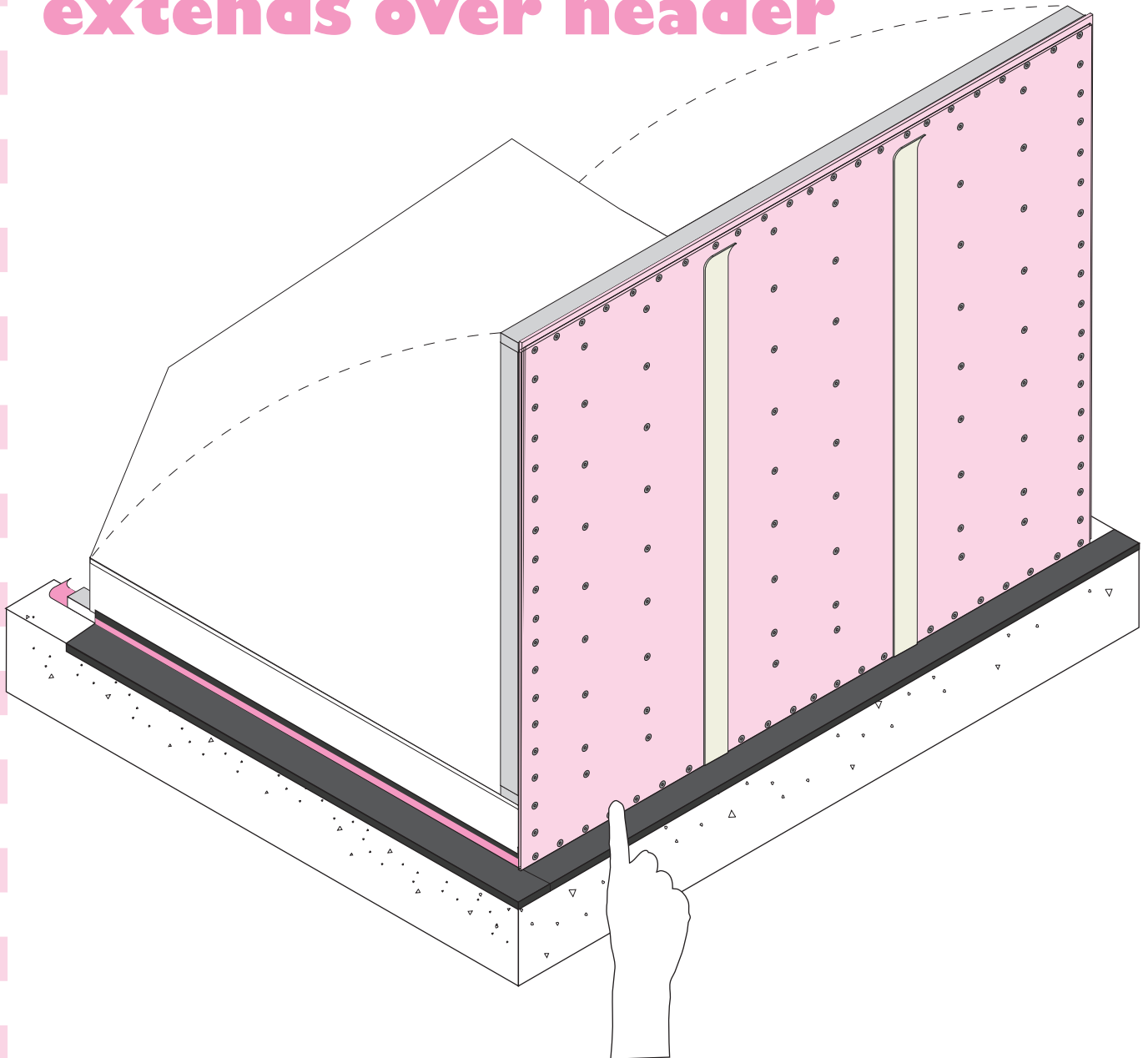

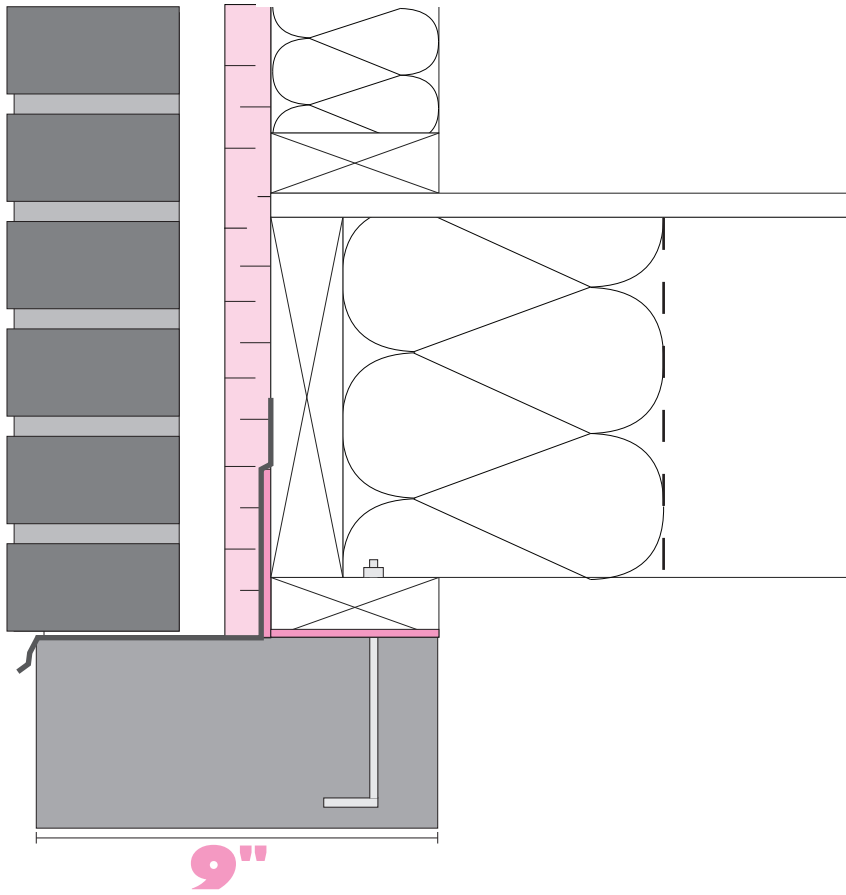

BRICK

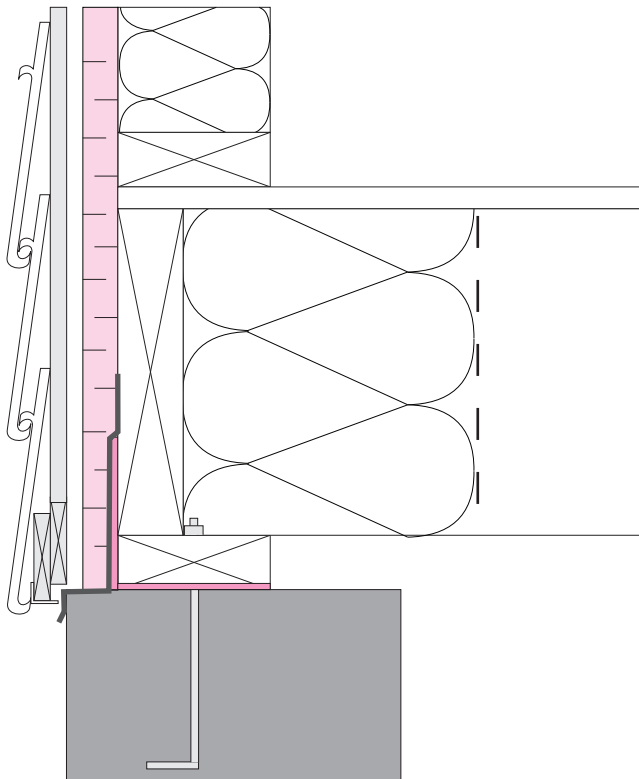

VINYL

strapping is optional





Secure the wall

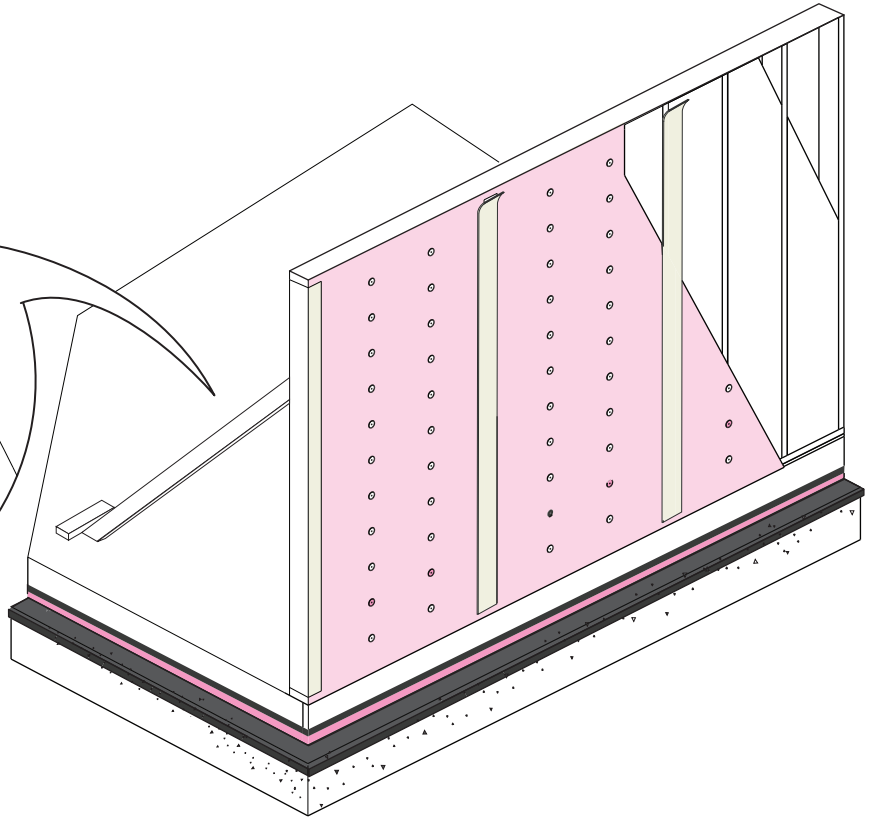
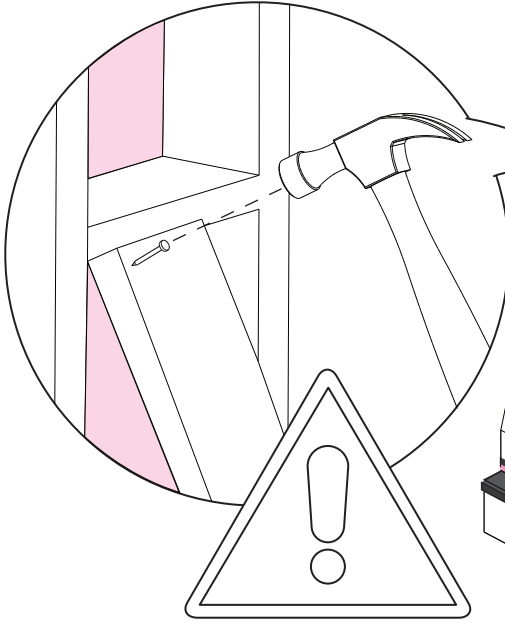

1

2

Complete first floor walls, install second floor

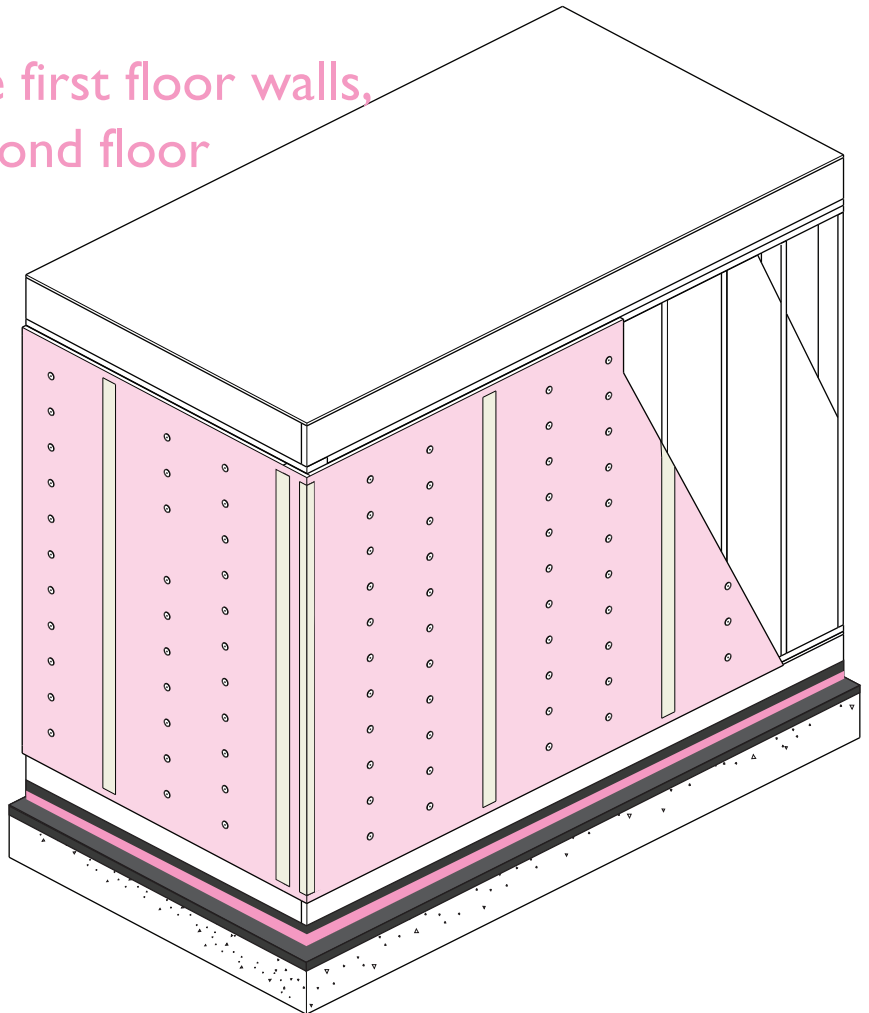

13 Install second floor walls and install gasket on ceiling top plate

Steps 14 to 17 show continuity of air barrier at the ceiling.

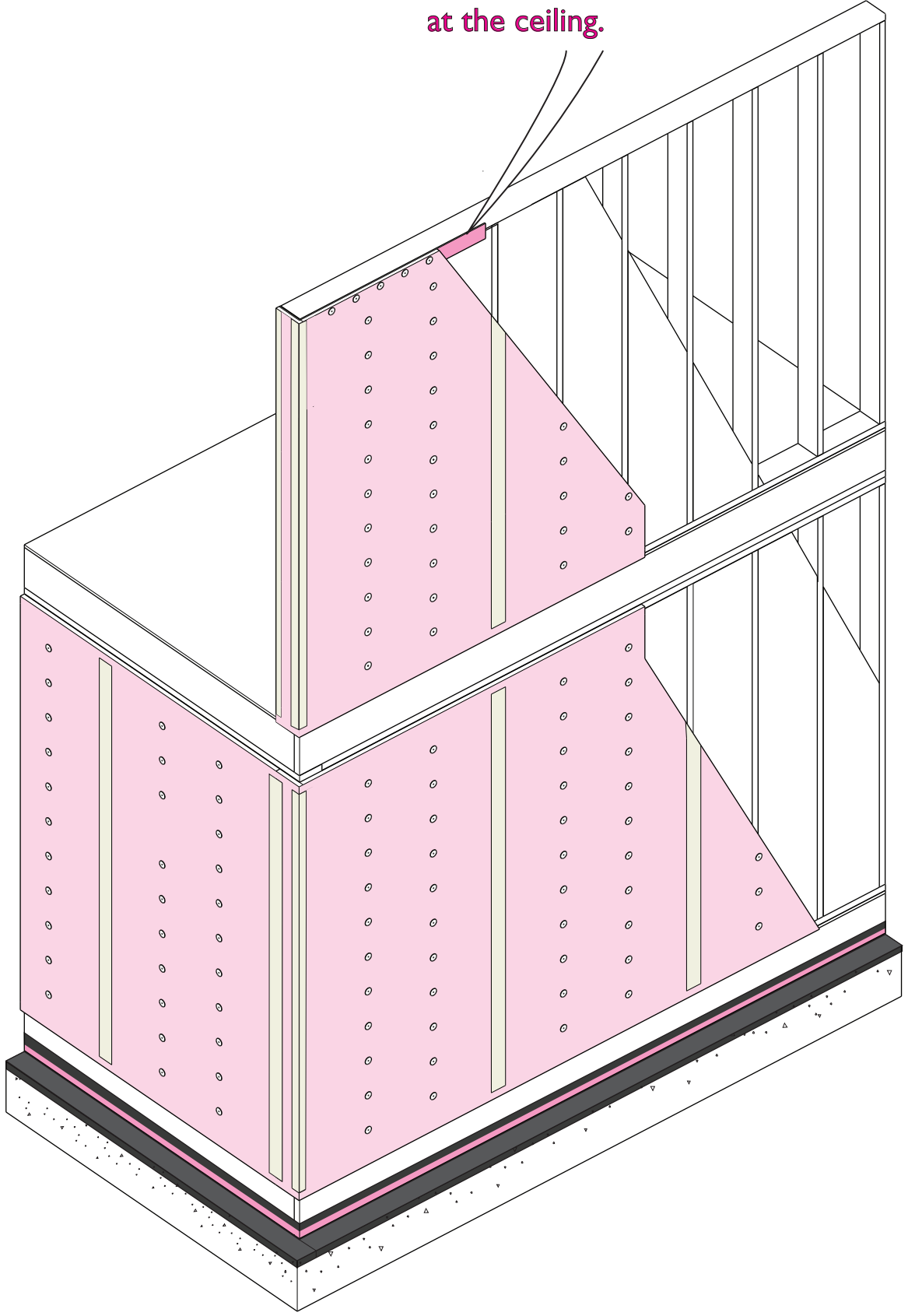

14

Install ceiling
a/v barrier

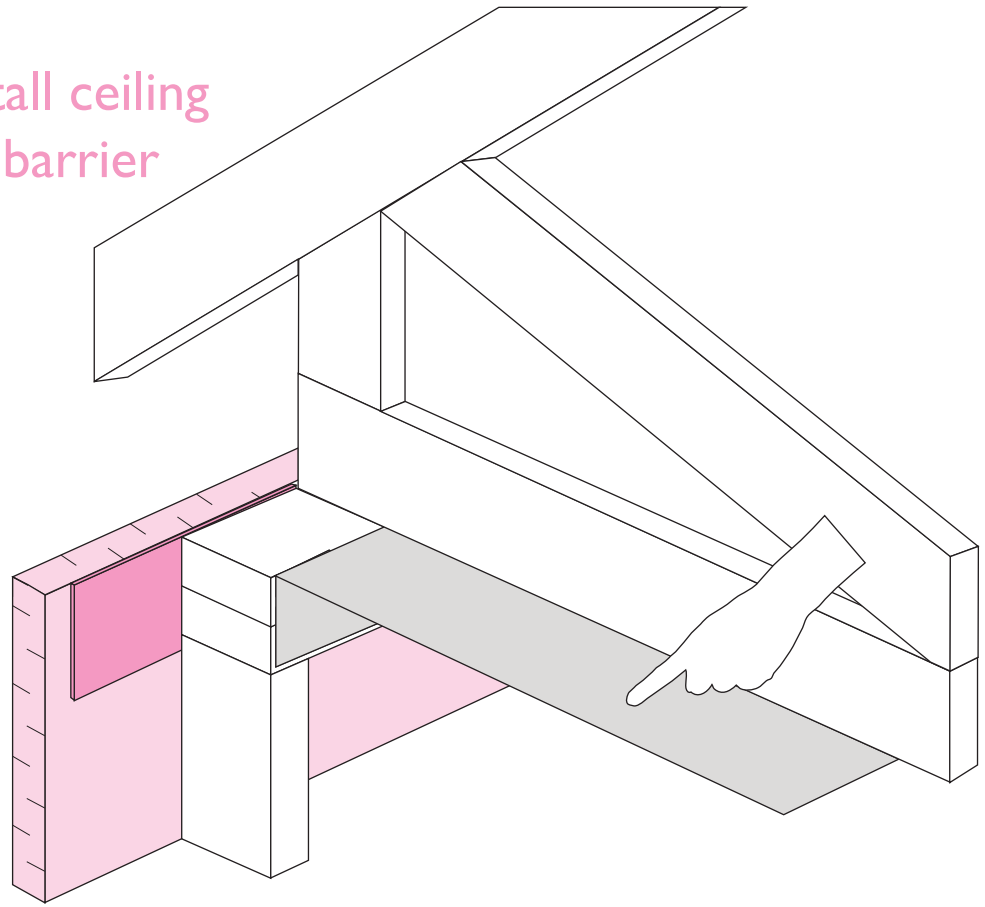

15

Install wall
vapour barrier

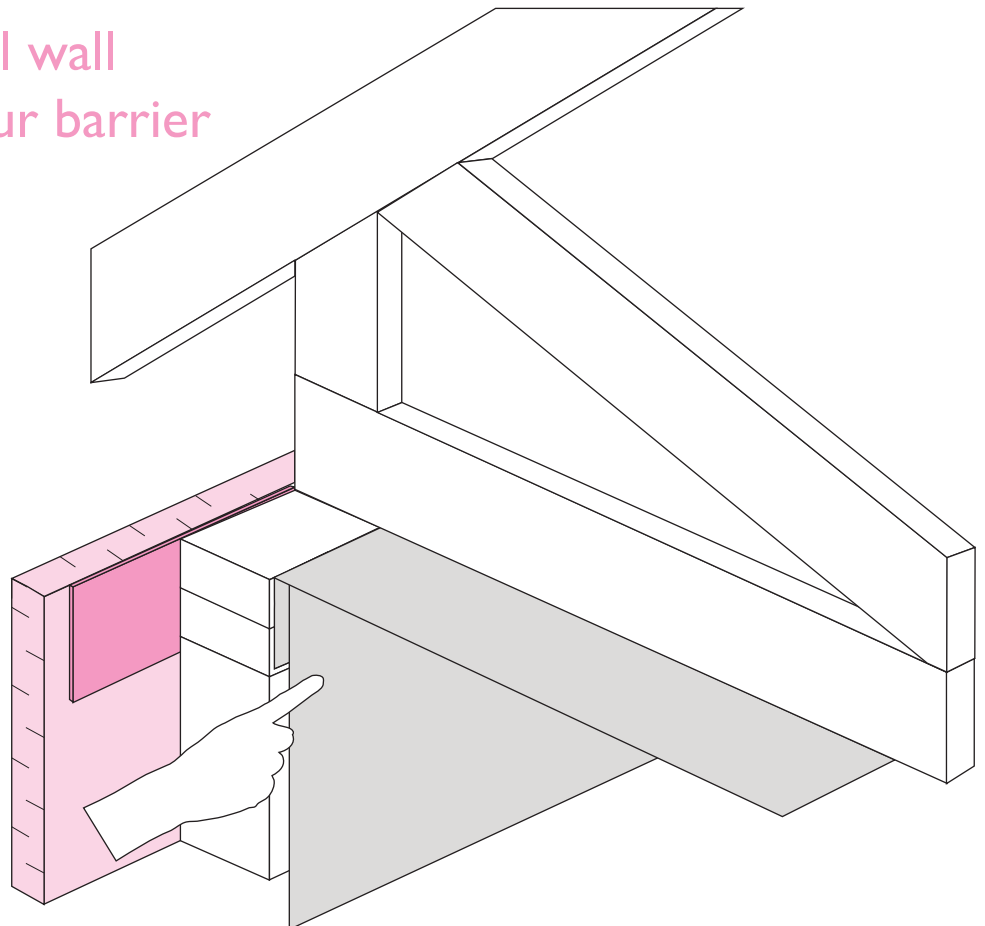

16 Install gasket

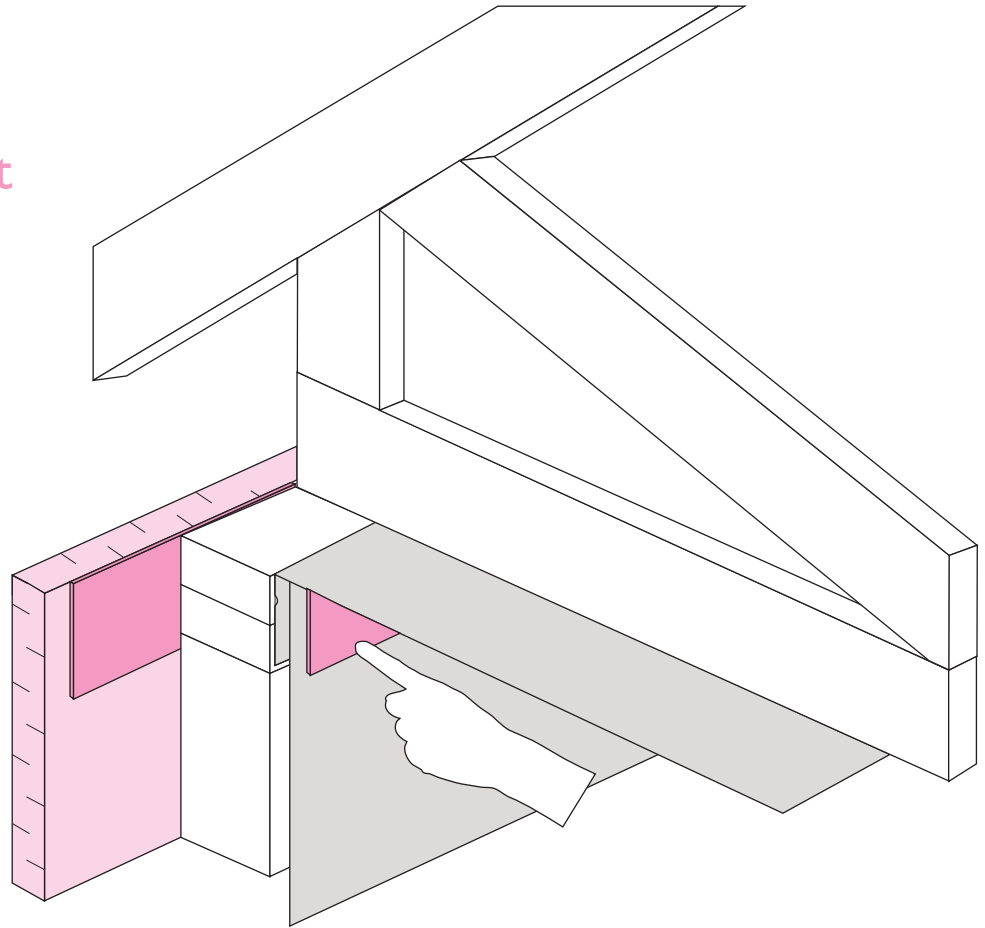

17 Install interior strapping

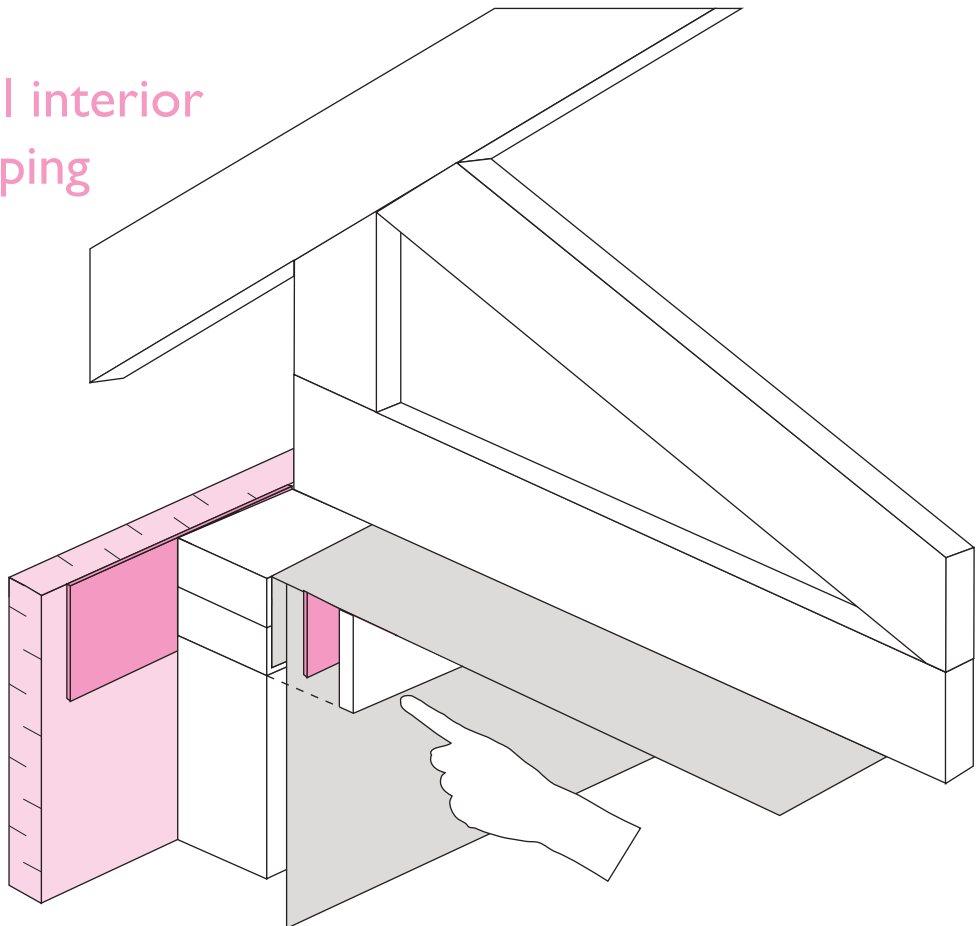



Alternative caulk ceiling poly

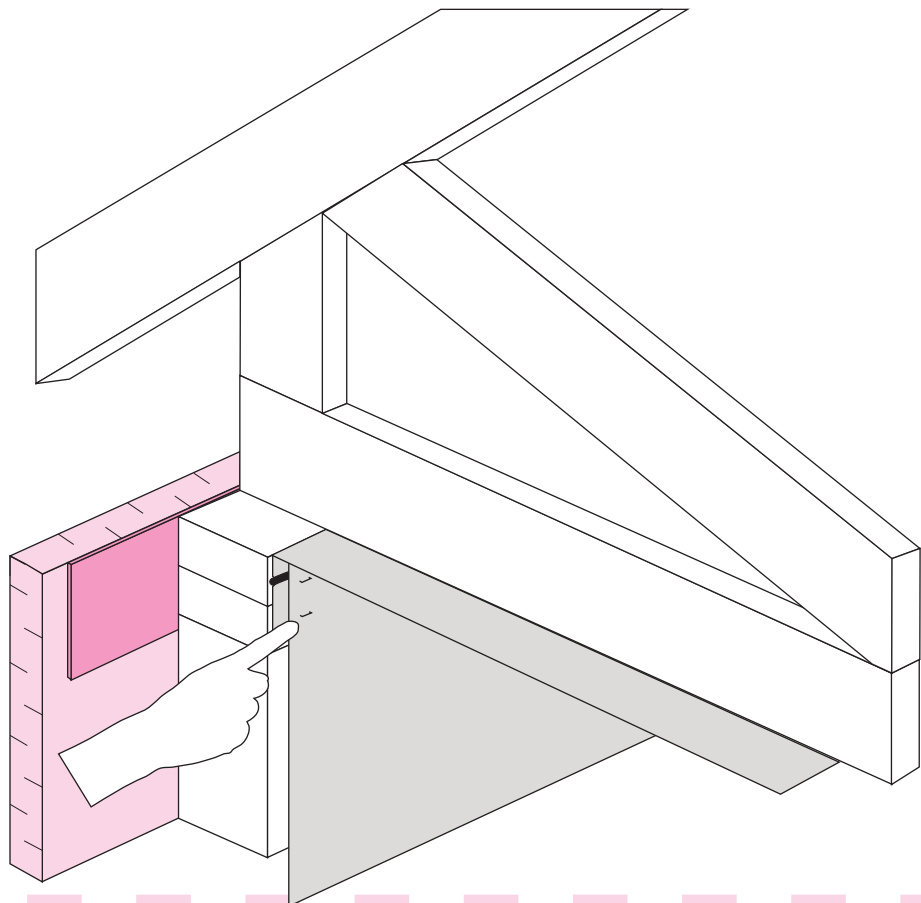
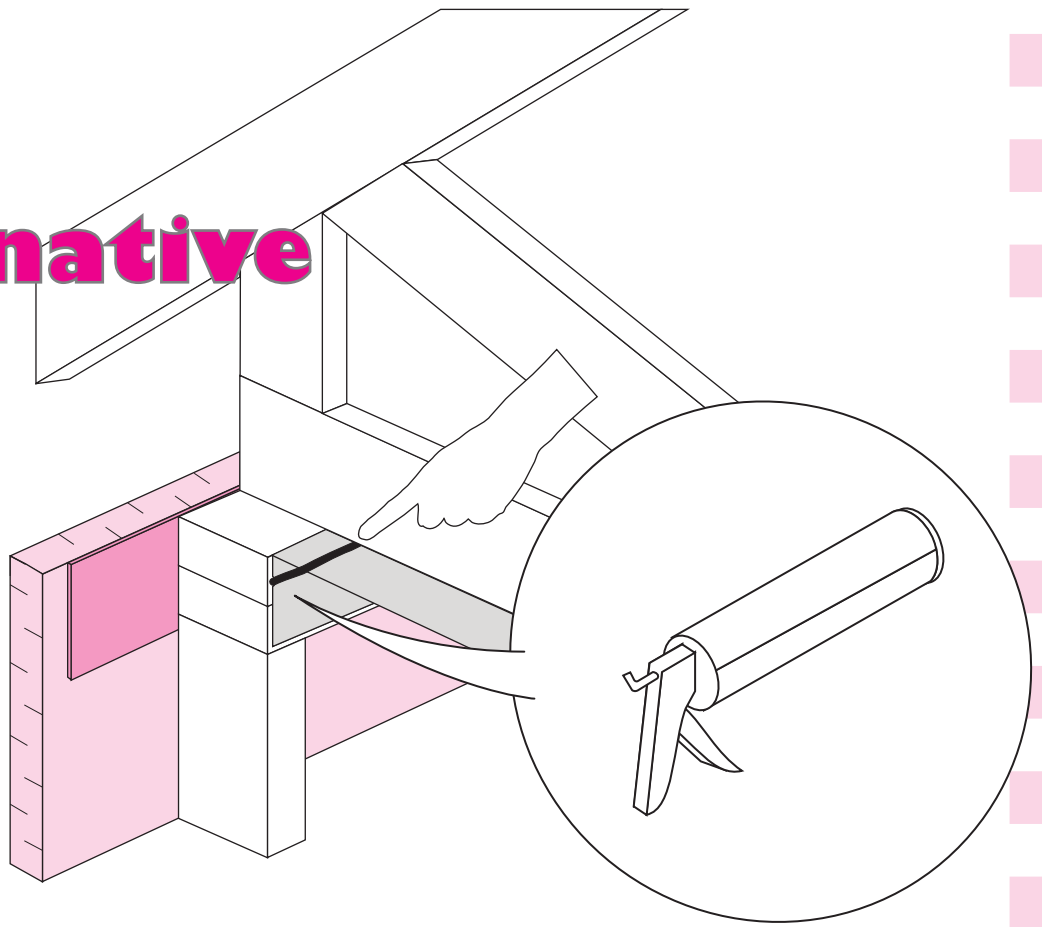

20 Install roof

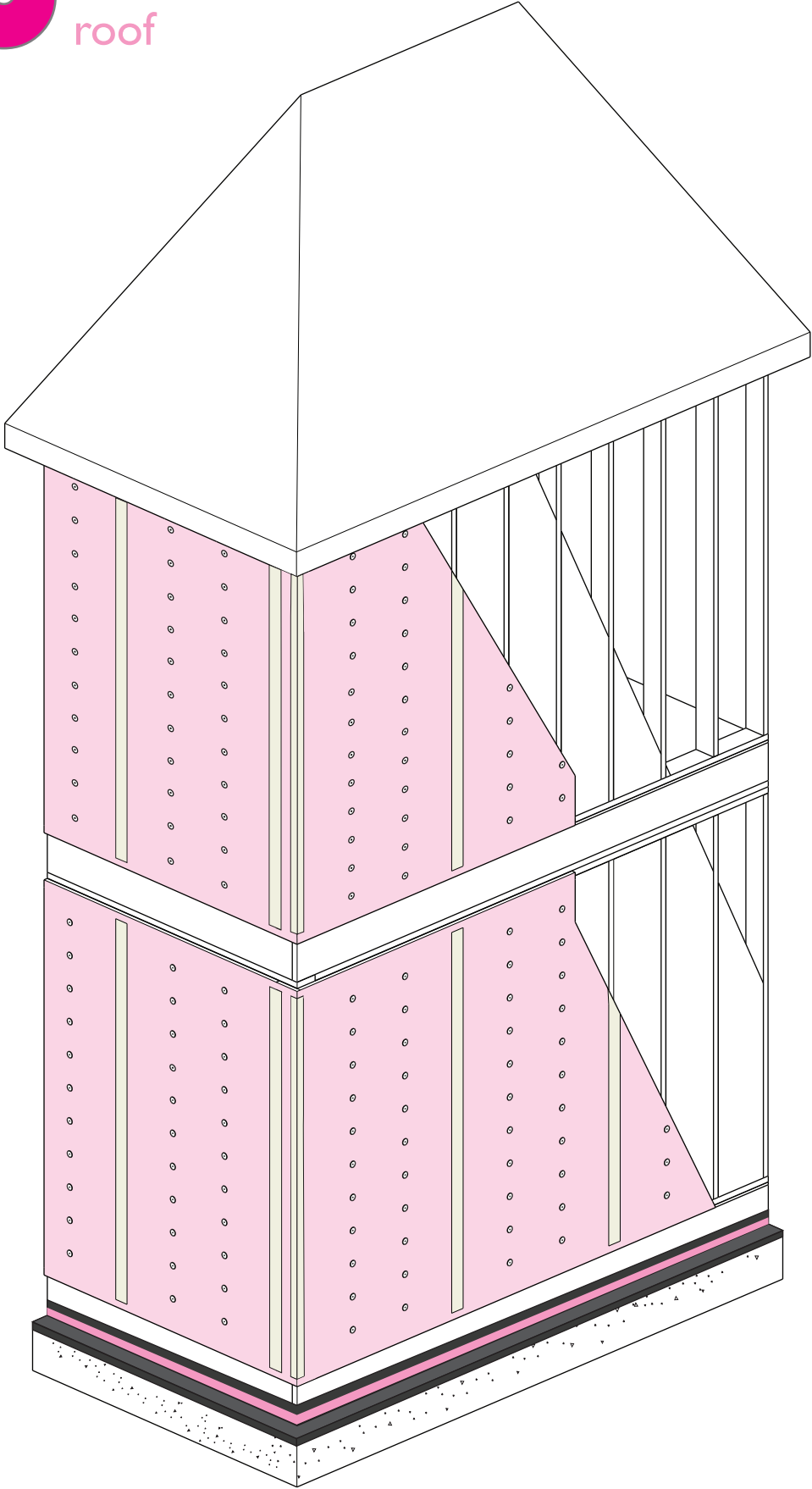

2 1 Install CodeBord® Insulation header piece and tape

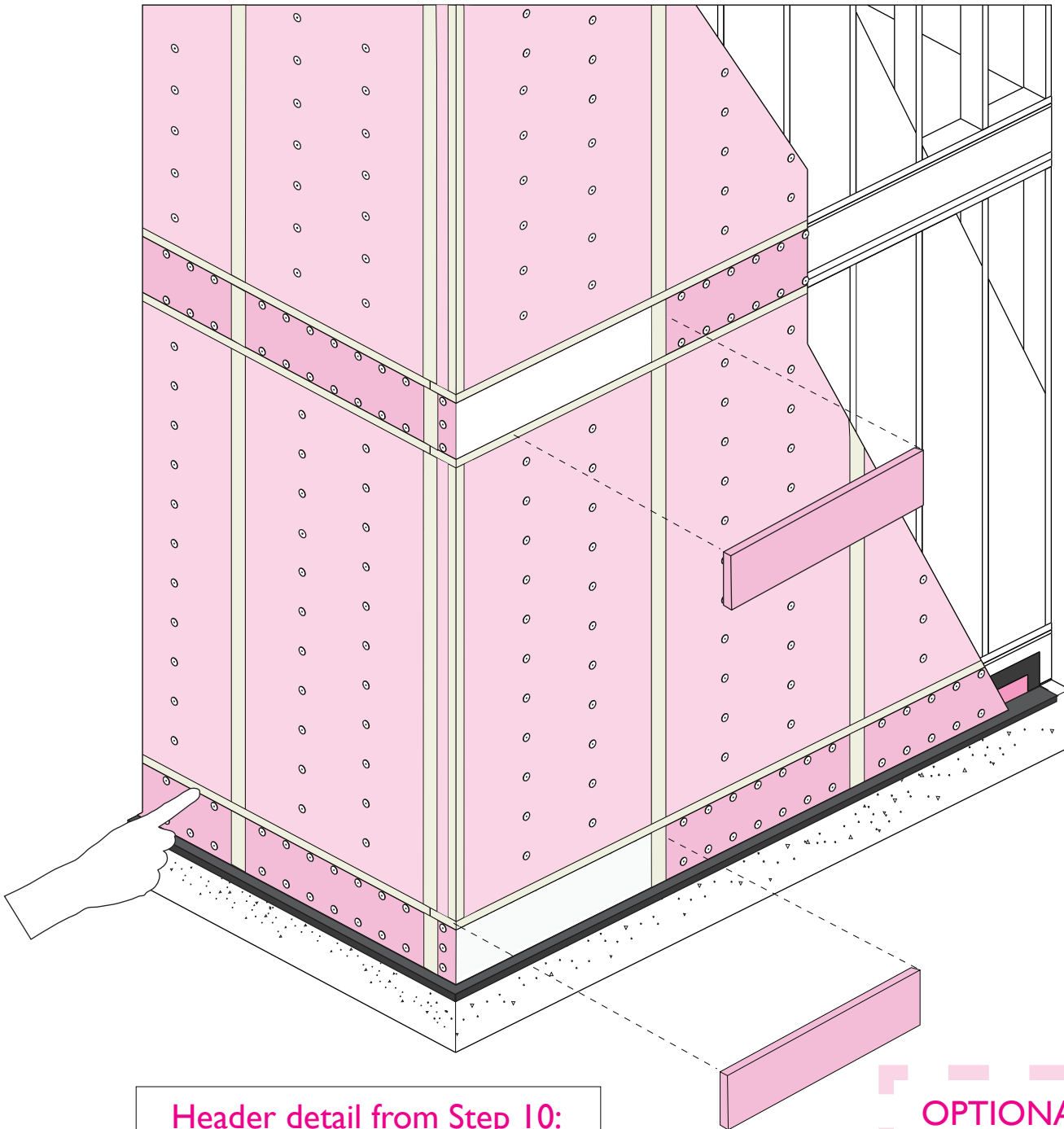

Header detail from Step 10:
CodeBord® Insulation
is now installed after all walls
are erected



OPTIONAL:
Header piece can
be inserted before
wall is erected

22

Proceed with exterior cladding

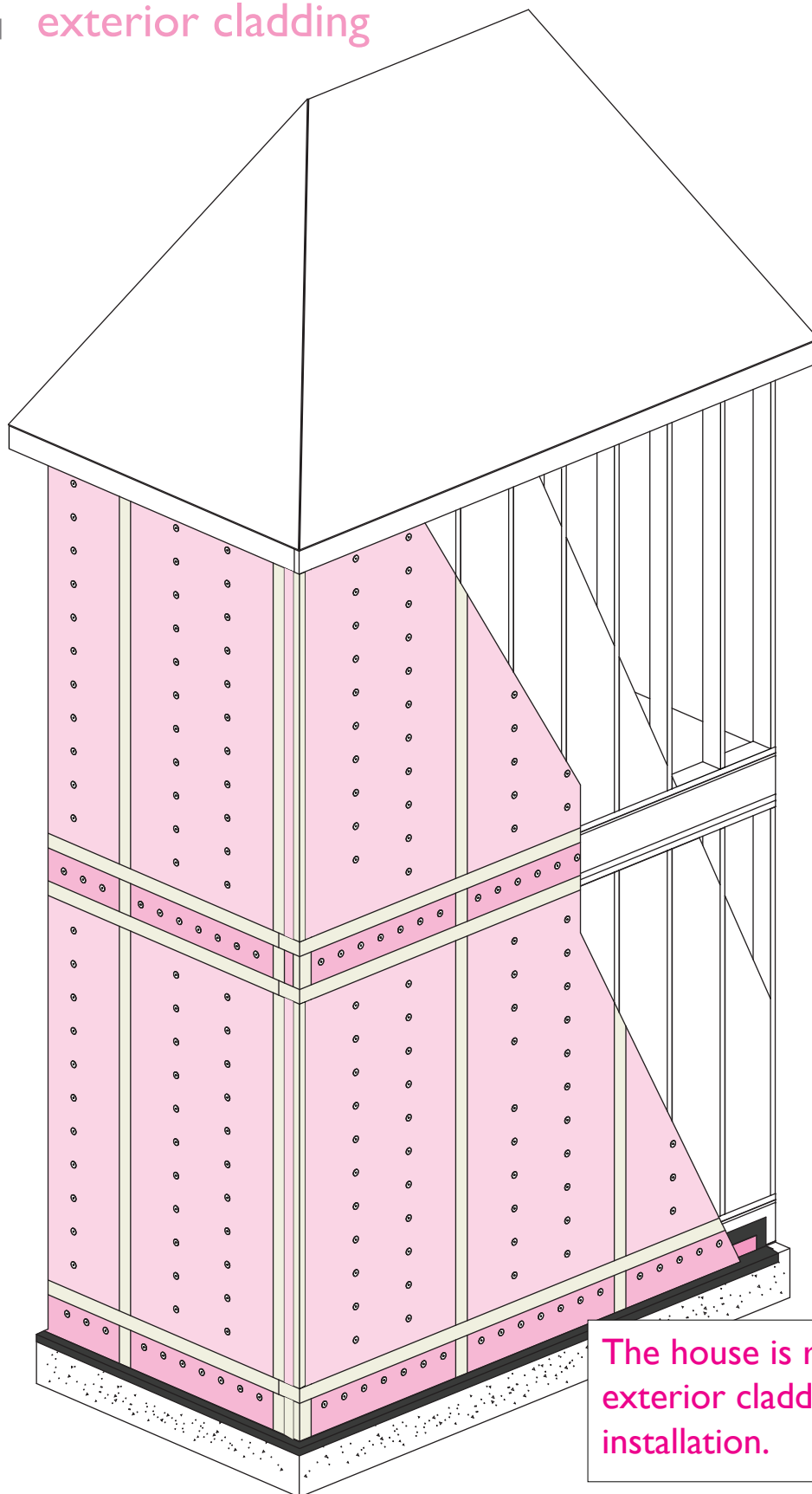

The house is ready for exterior cladding installation.



OPTIONAL:

Install strapping over header before proceeding with vinyl cladding

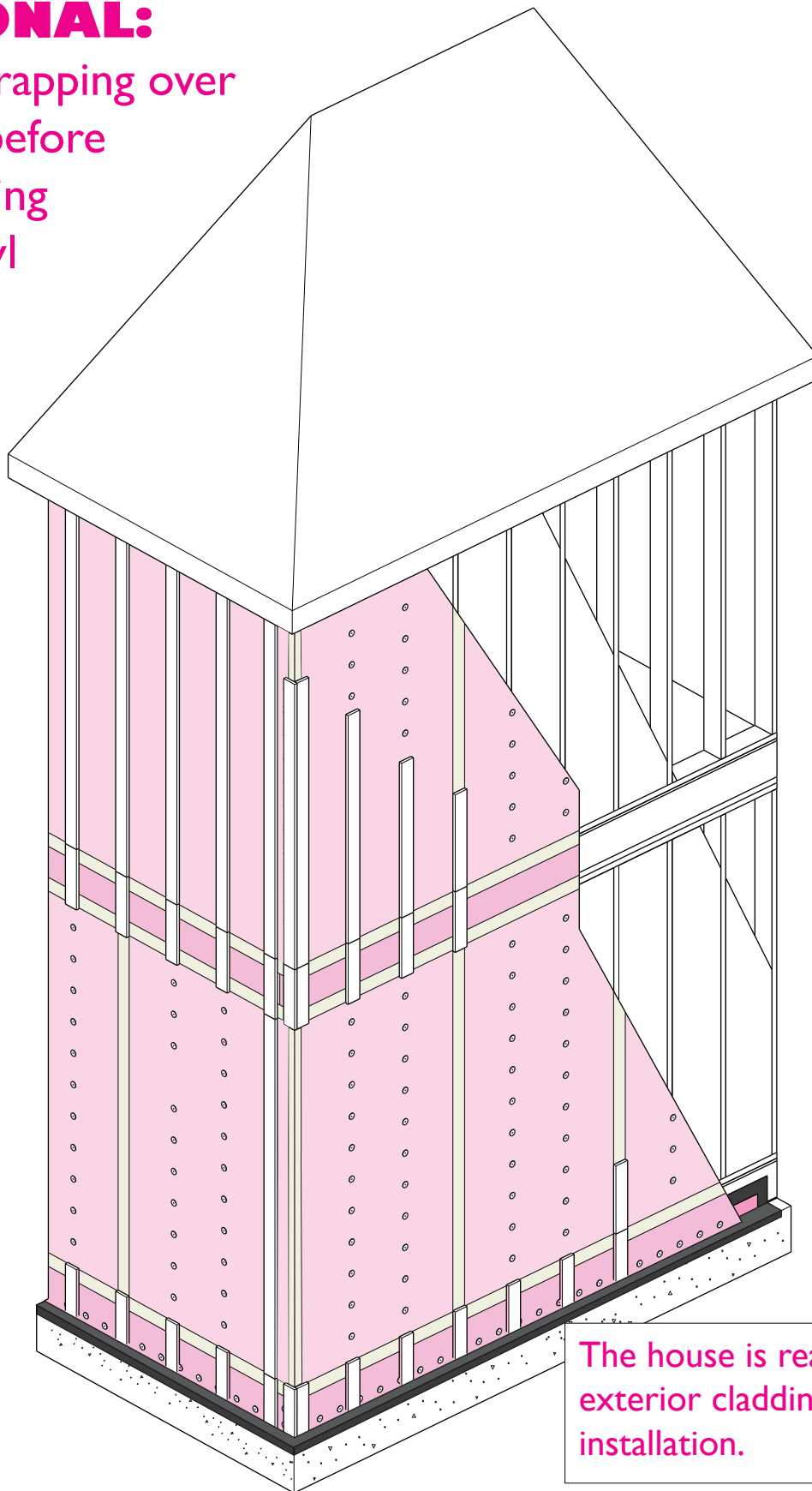

The house is ready for exterior cladding installation.





All rights reserved. No part of the work contained herein as covered by this copyright may be reproduced or used in any form, or any means - graphic, electronic or mechanical, including photocopying, recording, taping or information storage or retrieval systems - without the written permission of Owens Corning Canada LP. The colour PINK is a registered trademark of Owens Corning. © 2014 Owens Corning. All Rights Reserved.

DISCLAIMER

The procedures presented in this manual are intended as a guideline only, to provide a basic understanding of the concepts involved in the proper and effective installation of the Owens Corning CodeBord® Air Barrier System. It remains the responsibility of the air barrier system installer and/or builder to ensure that all work performed conforms to applicable building code and labour safety regulations governing the construction. While care has been taken to ensure accuracy, and convey proper construction practices, Owens Corning is not making, and specifically disclaims, any recommendations, warranties or guarantees, and further expressly disclaims any and all responsibility for consequential loss, errors or oversights resulting from the information contained herein. Our liability is expressly limited to replacement of defective Owens Corning™ goods. Any claim shall be deemed waived unless made to us in writing within thirty(30) days from the date when the basis for it was, or reasonably should have been, discovered.



INNOVATIONS FOR LIVING®

OWENS CORNING CANADA LP

3450 McNicoll Ave
Scarborough, ON, M1V 1Z5

1-800-GET-PINK®
www.owenscorning.ca

Pub No. 500668 Printed in Canada June 2014.

Additional copies of this publication may be obtained by visiting www.owenscorning.ca or calling toll free 1-800-GET-PINK® (1-800-438-7465).