

DELTA[®]-VENT SA

Self-Adhered Vapor Permeable Water-resistive & Air Barrier Installation Instructions Flange Window Strip-in Method

For other window installation methods, please refer to DELTA[®]-VENT SA Window Installation Guides

Health and Safety

- Required safety equipment: hard hat, safety boots, gloves, safety glasses, fall arrest equipment.
- Always follow all safety precautions as directed by the Occupational Safety and Health Administration (OSHA-USA) or the Construction Safety Association (Canada).
- Please refer to Safety Data Sheets for all components and observe all recommended safety precautions therein.
- The general codes of practice for protection at work and instructions of the manufacturers for tools and components are to be observed at all times.

Recommended Materials

- DELTA[®]-VENT SA
- DELTA[®]-HF PRIMER or DELTA[®]-ADHESIVE LVC
- DELTA[®]-FAS CORNER (pre-fabricated window corner)
- DELTA[®]-FLEXX BAND (flexible flashing)
- DELTA[®]-MULTI BAND tape
- DELTA[®]-FLASHING
- DELTA[®]-THAN or DELTA[®]-TILAXX

Recommended Tools

- Utility knife
- Measuring tape
- Hand roller (for membrane installation)
- Paint roller (for application of primer)

Notes on Air barrier Continuity

- To ensure the continuity of air and water-resistive barrier, it is essential to install DELTA[®]-VENT SA and all DELTA[®] components in a manner that seals all the potential leakage points:
 - Connections of the walls to the roof air barrier
 - Connections of the walls to the foundation
 - Seismic and expansion joints
 - Piping, conduit, duct and similar penetrations
 - Masonry ties, screws, bolts and similar penetrations
 - Changes in plane
 - All other potential air leakage pathways in the building enclosure
- These installation instructions for DELTA[®]-VENT SA are intended only as a guide and are for the convenience of the contractors, specifiers, and other interested parties. The final application and details are the sole responsibility of the design authority on record for the project.
- Applications using cementitious coating directly applied to surface of the DELTA[®]-VENT SA is not recommended. For these application, please call our Technical Support Team: 1-888-433-5824 ext. 326.
- DELTA[®]-VENT SA membrane should be installed at 40°F (4°C) and above. In cold weather, store rolls in warm area to enhance adhesion and workability. Do not install DELTA[®]-VENT SA in adverse weather conditions. High winds may hamper application.
- All surfaces must be sound, dry, clean and free of dust, oil, grease, dirt, excess mortar or other contaminants detrimental to the adhesion of the membrane.
- Ensure protrusions that may penetrate the membrane are removed from substrate.
- If being applied to concrete or masonry substrates fill voids, gaps and spalled areas in substrate to provide an even plane. Strike masonry joints full-flush.
- It is recommended that DELTA[®]-VENT SA be installed prior to the installation of seismic straps.
- Curing compounds or release agents used in concrete construction must be resin-based without oil, wax or pigments.
- For optimum adhesion, prime substrates including exterior-grade gypsum board, OSB, plywood, CMU, DELTA[®]-HF PRIMER or DELTA[®]-ADHESIVE LVC.
- If sealant is required, DELTA[®]-THAN or DELTA[®]-TILAXX is recommended.
- When attaching brick ties for anchoring masonry claddings after the installation of DELTA[®]-VENT SA, install a patch of DELTA[®]-FLEXX BAND at the penetration site before installing the brick tie. The patch should be of an adequate size to seal only the penetration point.

- Product is not designed for permanent UV exposure. Always cover as soon as possible.

Step 1 Installation

- If primer is being used, apply to substrate at recommended application rate. Apply only to areas where membrane will be applied that day.
- Cut DELTA®-VENT SA into manageable length. DELTA®-VENT SA can be installed vertically or horizontally.
- Starting at the corner of the building, align and position DELTA®-VENT SA to substrate. Remove release liner from top half of sheet and press DELTA®-VENT SA firmly into place. Ensure proper alignment of membrane to avoid wrinkles.
- Remove bottom half of release liner and press DELTA®-VENT SA firmly into place.
- At end laps, overlap DELTA®-VENT SA by minimum of 6" (150 mm). To ensure air barrier continuity tape any laps without the self-adhering edge with DELTA®-MULTI BAND tape.
- At side laps, overlap DELTA®-VENT SA by minimum 4" (100 mm) ensuring upper course completely overlaps glue strip on lower course. Remove overlap release liner and press firmly together.
- Always begin the installation of DELTA®-VENT SA at bottom of the building to ensure proper downward shingling of side laps.
- Using hand roller, firmly roll all membrane surfaces to ensure appropriate adhesion.

Step 2 Wall/foundation transition

- If through-wall flashing (DELTA®-TW) is installed, DELTA®-VENT SA should overlap by minimum of 6"
- If no through-wall flashing is installed, the bottom edge of DELTA®-VENT SA should extend beyond the sill plate by at least 2" (50 mm). Seal bottom edge with DELTA®-FLASHING or DELTA®-FLEX BAND. Use hand roller firmly to ensure appropriate adhesion. To ensure proper adhesion, prime substrate with DELTA®-HF PRIMER or DELTA®-ADHESIVE LVC.

Step 3 Window

- Install DELTA®-FAS CORNER in lower corners of rough opening. Staple on vertical leg for temporary support (see Detail 1).
- Install DELTA®-VENT SA membrane below window with cut out minimum 8" (200 mm) above sill. Install DELTA®-FLASHING membrane at sill. Overlap 2" (50 mm) onto vertical DELTA®-VENT SA membrane below (see Detail 2).
- Install DELTA®-VENT SA membrane strip to wrap jamb. Lap 8" (200 mm) onto face of wall at jamb, minimum 3" (75 mm) at head. Install DELTA®-VENT SA membrane at head of rough opening. Lap minimum 8" (200 mm) onto face of wall at head. Install DELTA®-MULTI-BAND tape at overlapped edges of DELTA®-VENT SA to ensure airtightness (see Detail 3).
- Install window shims in accordance with window manufacturer's specifications, typically at quarter points of rough opening and under setting block locations for window. Install window in accordance with manufacturer's specifications. Generally, the gap between window and rough opening should be around 1/2" (12 mm).
- From interior, install backer rod around the full perimeter of window. Install DELTA®-TILAXX sealant around perimeter of window alternate air sealing detail; Apply low expansion spray foam around full perimeter of window. Do not seal full cavity to allow drainage from sill flashing.

Step 4 Installation of membrane

- Prime sheathing with DELTA®-HF PRIMER or DELTA®-ADHESIVE LVC before applying DELTA®-VENT SA.
- Install DELTA®-VENT SA membrane overlapping window flange and extending minimum 3" (75 mm) above top flange.
- Tape DELTA®-VENT SA to window flange at both jambs with DELTA®-MULTI-BAND tape or DELTA®-FLASHING 6".
- Install DELTA®-VENT SA membrane above head of window, overlapping window flange and lower membrane sheets (see Detail 5).
- Install DELTA®-MULTI-BAND tape at overlapped edges of DELTA®-VENT SA to ensure airtightness (see Detail 6).
- Using hand roller, firmly roll all membrane surfaces to ensure appropriate adhesion.

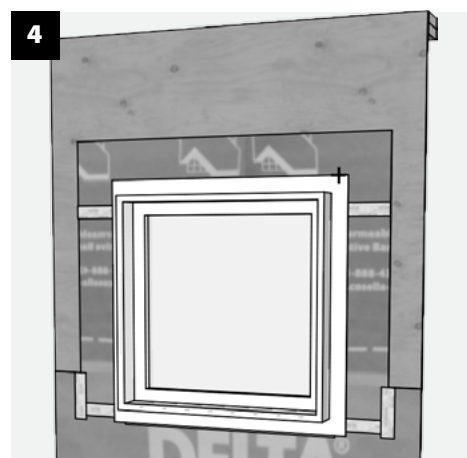
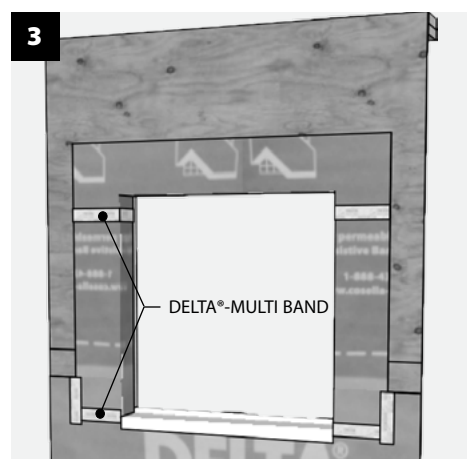
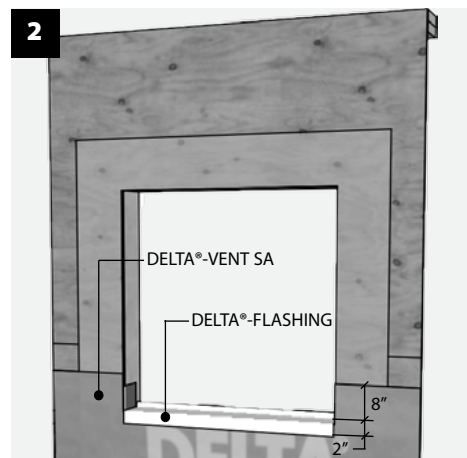
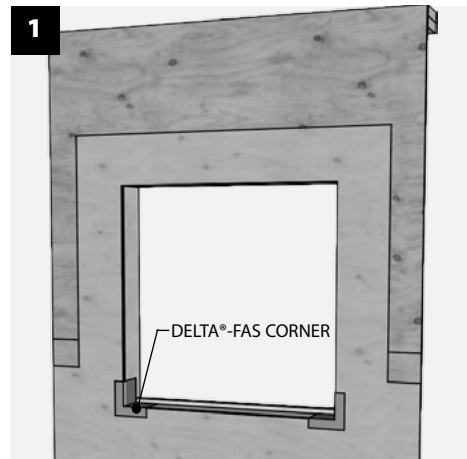

Step 5 Penetrations

- Cut DELTA®-VENT SA around penetrations as tightly as possible.
- Seal gaps between penetration and substrate with DELTA®-THAN or DELTA®-TILAXX sealant.
- Install DELTA®-FLEXX BAND around the penetration (see Detail 7).

Step 6 Inspection

- Inspect the DELTA®-VENT SA for rips, tears, or other installation deficiencies in the continuity. Tape rips, tears or holes smaller than 2" (50 mm) with DELTA®-MULTI BAND.
- For holes greater than 2" (50 mm), a patch is required.
 - Cut a patch minimum 6" (150 mm) larger than the hole. Install patch of DELTA®-VENT SA over the hole.
 - Remove release liner, press the patch firmly into place, and hand roll.
 - Tape the patch with DELTA®-MULTI BAND in the following order:
 1. Bottom
 2. Sides
 3. Top

Step 7

- Clean up all excess materials and dispose of properly.

For technical support, call our Technical Support Team at 1-888-433-5824 extension 326, or visit www.dorken.com

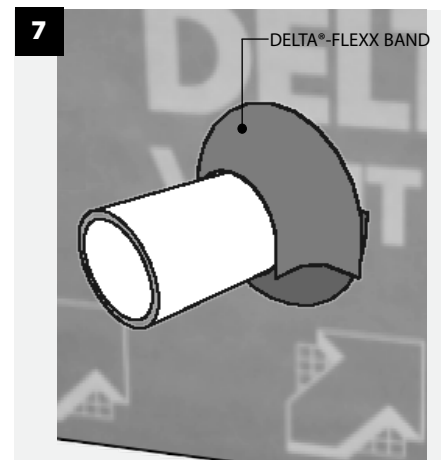
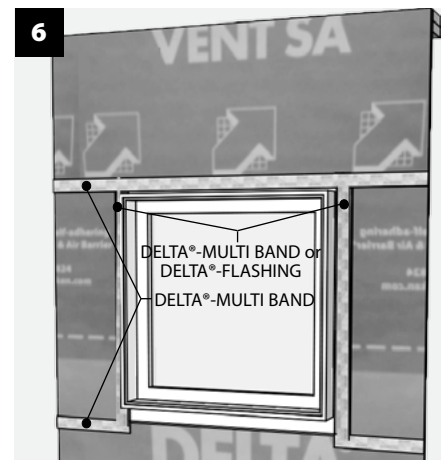
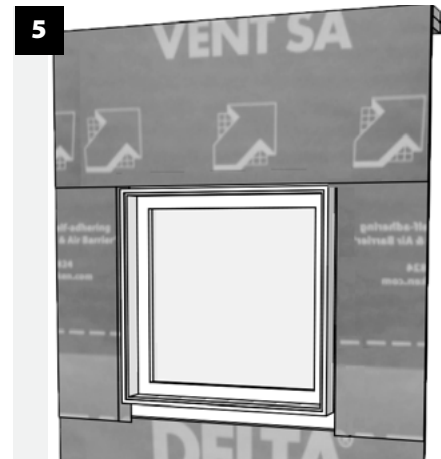

DELTA® is a registered trademark of Ewald Dörken AG, Herdecke, Germany

DÖRKEN Dörken Systems Inc.
4655 Delta Way
Beamsville, Ontario
L0R 1B4
1-(905) 563-3255
Fax: (905) 563-5582
info@dorken.com
www.dorken.com

A **DÖRKEN** GROUP company



DELTA®-branded quality products
manufactured by Dörken.

The information printed in this brochure reflects product information and specifications at the date of printing. The manufacturer reserves the right to make changes when necessary. All rights reserved.