

## SUPPLEMENTARY INSTALLATION INSTRUCTIONS

### Ventilating Fan (Contractor Pack)

Model No. FV-07VB1

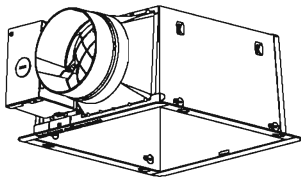

Housing Can:  
FV-07VBA1

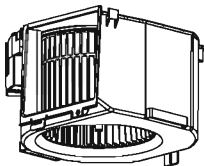

Motor / Grille Assembly:  
FV-07VBB1

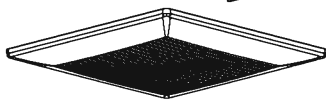

#### CONTENTS

GENERAL SAFETY INFORMATION .....	2-3
DESCRIPTION .....	4
UNPACKING .....	4
SUPPLIED ACCESSORIES .....	4
DIMENSIONS .....	4
WIRING DIAGRAM .....	5
INSTALLATION FOR FV-07VBA1 (JOIST MOUNTING) ..	5-6
INSTALLATION FOR FV-07VBB1 .....	6-7
MAINTENANCE (CLEANING) .....	7
PRACTICAL GUIDE TO INSTALLATION ..	BACK COVER
SPECIFICATIONS .....	BACK COVER
PRODUCT SERVICE .....	BACK COVER

#### READ AND SAVE THESE INSTRUCTIONS

Thank you for purchasing this Panasonic product.

Please read these instructions carefully before attempting to install, operate or service the Panasonic product. Failure to comply with instructions could result in personal injury or property damage. Please explain to users how to operate and maintain the product after installation, and this booklet should be presented to users.

Please retain this booklet for future reference.

---

## GENERAL SAFETY INFORMATION

---

### For Your Safety

To reduce the risk of injury, loss of life, electric shock, fire, malfunction, and damage to equipment or property always observe the following safety precautions.

#### Explanation of symbol word panels

The following symbol word panels are used to classify and describe the level of hazard, injury, and property damage caused when the denotation is disregarded and improper use is performed.



Denotes a potential hazard that could result in serious injury or death.











Denotes a hazard that could result in minor injury.

The following symbols are used to classify and describe the type of instructions to be observed.

	This symbol is used to alert users to a specific operating procedure that must not be performed.
	This symbol is used to alert users to a specific operating procedure that must be followed in order to operate the unit safely.
	This symbol is used to alert users not to disassemble the equipment.
	This symbol is used to alert users to make sure of grounding when using the equipment with the grounding terminal.











To reduce the risk of fire, electric shock or injury to persons, observe the following :











-  Use this unit only in the manner intended by the manufacturer. If you have any questions, contact the manufacturer.
-  Before servicing or cleaning unit, switch power off at service panel and lock the service disconnecting means to prevent power from being switched on accidentally. When the service disconnecting means cannot be locked, securely fasten a prominent warning device, such as a tag, to the service panel.
-  Installation work and electrical wiring must be done by qualified person(s) in accordance with all applicable codes and standards, including fire-rated construction.
-  Sufficient air is needed for proper combustion and exhausting of gases through the flue (chimney) of fuel burning equipment to prevent back drafting. Follow the heating equipment manufacturer's guideline and safety standards such as those published by the National Fire Protection Association (NFPA), and the American Society for Heating, Refrigeration and Air Conditioning Engineers (ASHRAE) and the local code authorities.
-  When cutting or drilling into wall or ceiling, do not damage electrical wiring and other hidden utilities.
-  Ducted fans must always be vented to the outdoors.
-  If this unit is to be installed over a tub or shower, it must be marked as appropriate for the application and be connected to a GFCI (Ground Fault Circuit Interrupter) - protected branch circuit.
-  The model is UL listed for tub and shower enclosures.

## GENERAL SAFETY INFORMATION CONTINUED

### ⚠ WARNING

-  Canada only: Not to be installed in a ceiling thermally insulated to a value greater than R40.
-  Do not disassemble the unit for reconstruction. It may cause fire or electric shock.
-  When this product is no longer being operated, please remove the product to prevent the possibility of falling.
-  Ceiling joist must be subjected to static load more than five times the weight of the product.
-  Do not install with a method which is not approved in the instructions.
-  Do not use this fan with any solid-state speed control device. Solid state controls may cause harmonic distortion which can cause motor humming noise.
-  The Motor / Grille Assembly FV-07VBB1 must be installed with Housing Can FV-07VBA1 that is marked on the Carton to indicate the suitability with this model. Other Motor / Grille Assembly can not be substituted.
-  This product must be properly grounded.
-  When one switch is connected with two or more products in parallel, the unit may not function. Therefore, parallel connection must not be allowed.

### ⚠ CAUTION

-  Do not install this ventilating fan where interior room temperature may exceed 104°F (40°C).
-  Make sure that the electric service supply voltage is AC 120V, 60 Hz.
-  Follow all local electrical and safety codes, as well as the National Electrical Code (NEC) and the Occupation Safety and Health Act (OSHA).
-  Always disconnect the power source before working on or near the blower, motor, or junction box.
-  Protect the supply wiring from sharp edges, oil, grease, hot surfaces, chemicals or other objects.
-  Do not kink the supply wiring.
-  Provide make up air for proper ventilation.
-  For general ventilating use only. Do not use to exhaust hazardous or explosive materials and vapors.
-  Do not install the unit where ducts are configured as shown in Fig.A.
-  Not for use in cooking area. (Fig.B)
-  The special-purpose or dedicated parts, such as mounting fixtures, must be used if such parts are provided.

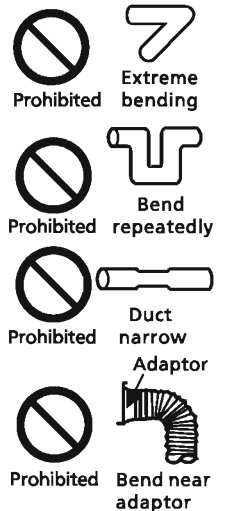

Fig.A

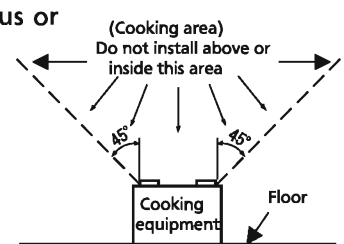

Fig.B

## DESCRIPTION

The Panasonic ventilating fan model is listed by UL under UL file No. E78414.

The Panasonic ventilating fan model uses a sirocco Blower driven by a capacitor motor.

The motor is designed to have an extended service life with reduced energy consumption.

It also incorporates a thermal-cutoff for safety. The Grille Assembly covering the Fan Body is a spring-loaded, quick remove type. A damper for preventing air counterflow is provided. The Blower uses a high-capacity sirocco Blower developed to reduce the noise level.





The Panasonic ventilating fan has two speeds. "I" (Standard) is low airflow and "II" (Boost) is high airflow.



## UNPACKING

Unpack and carefully remove the unit from carton, in case the foam scraps fall into the Motor Assembly. Refer to the supplied accessories list to verify that all parts are present.



## SUPPLIED ACCESSORIES

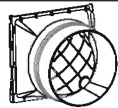

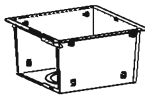
(A) For Housing Can of Model: FV-07VBA1

Part name	Appearance	Quantity
Long screw (ST4.2X30)		16
Screw I (ST4.2X8)		4
Spacer		8
Installation instructions		2

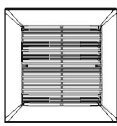
Part name	Appearance	Quantity
Adaptor		4
Junction Box		4
Fan Housing		4

(B) For Motor / Grille Assembly of Model: FV-07VBB1

Part name	Appearance	Quantity
Grille Assembly		4
Installation instructions		2

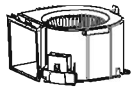
Part name	Appearance	Quantity
Warranty sheet		1
Screw I (ST4.2X8)		8
Blower / Motor Assembly		4

## DIMENSIONS

Unit: inches (mm)

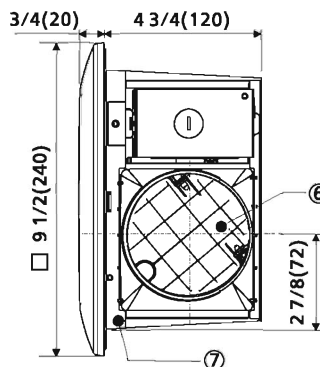
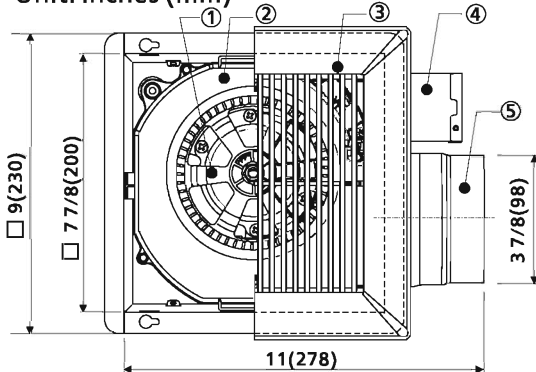

No.	Part name
①	Blade
②	Blower / Motor Assembly
③	Grille Assembly
④	Junction Box
⑤	Adaptor
⑥	Damper
⑦	Fan body

# WIRING DIAGRAM

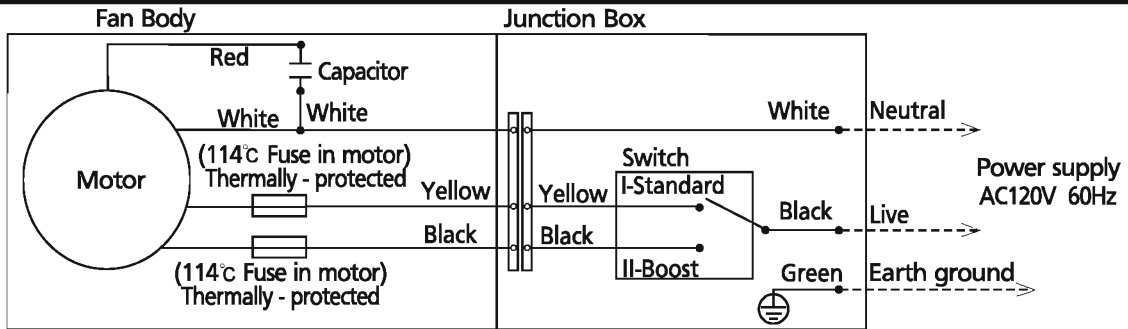

## INSTALLATION FOR FV-07VBA1(JOIST MOUNTING)

1. Before installation, use Flathead screwdriver to knock out the two screw holes on the side of the Fan Housing that will be fixed to the Joist. (Fig.1)
2. Take the tape off the two holes on the side of the Fan Housing which will be fixed to the Joist and gently install the 2 Spacers to the outside of the Fan Housing. (Fig.1)
3. Affix the Fan Housing to Joist with 4 Long screws (ST4.2X30). (Fig.2)
4. Install the Ventilation duct and secure it with a Clamp and seal it with approved Mastic tape or Mastic. (Fig.3)
5. Slide the Clamps of the Adaptor to the top of the Fan Housing and then snap the Clamps of the Adaptor into the bottom of the Fan Housing opening. (Fig.3)

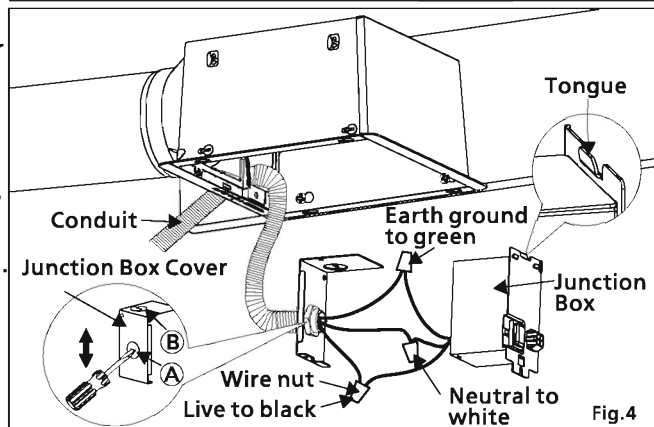
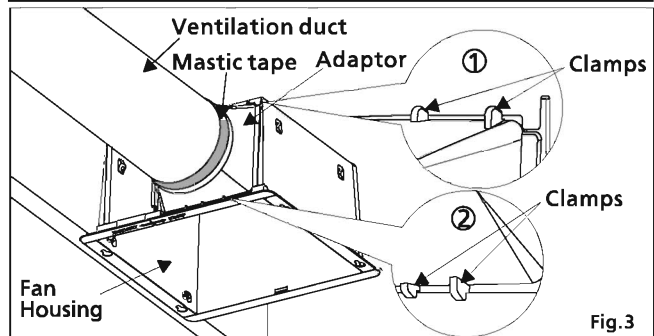
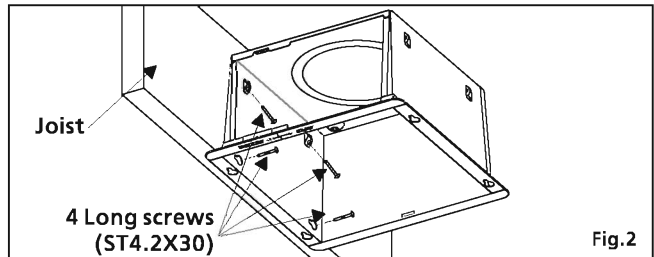
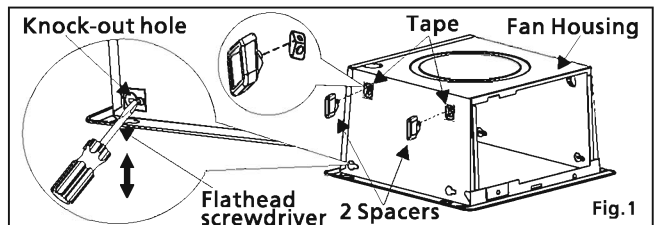

### CAUTION

- ! Install the Adaptor and secure Ventilation duct before installing Junction Box.
  - ! The Clamps of the Adaptor should be clipped on Fan Housing correctly.
6. Remove Junction Box Cover and secure Conduit or strain relief to Junction Box Cover Knock-out hole (A) or (B). (Fig.4)
  7. Refer to wiring diagram. Follow all the local electrical safety codes as well as the National Electrical Code(NEC). Using UL approved Wire nuts, connect house power wires to ventilating fan wires.
  8. Affix the Junction Box Cover to Junction Box. If the Knock-out hole is used (B), this step must be performed after step 9.
  9. Insert the Tongue on the bottom of the Junction Box so that it is on the outside of the Fan Housing.

## INSTALLATION FOR FV-07VBA1 CONTINUED

10. Affix the Junction Box to the top of the Fan Housing with Screw I (ST4.2X8). (Fig.5)

### CAUTION

- ❗ Before affixing the screw I (ST4.2X8), make sure the Tongue of the Junction Box is clipped on Fan Housing correctly. (Fig.4 of page 5)
- ❗ Mount Junction Box Cover carefully so that lead wires are not pinched.

11. Select the air volume speed by adjusting the Switch. Factory setting is "I" (Standard) position; pressing "II" (Boost) selects the high airflow position. (Fig.5)
12. Finish Ceiling work. Ceiling hole should be aligned with the inside edge of the flange. (Fig.6)

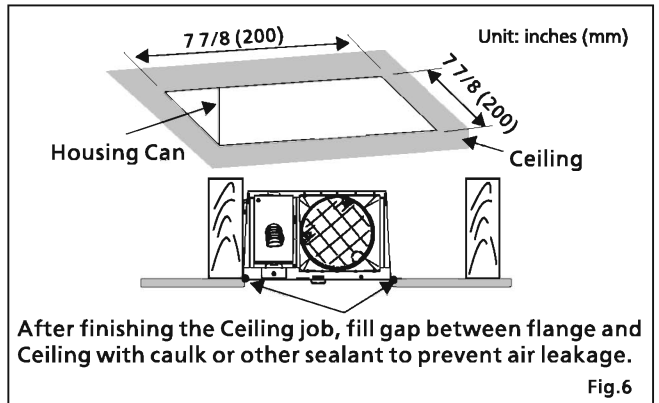
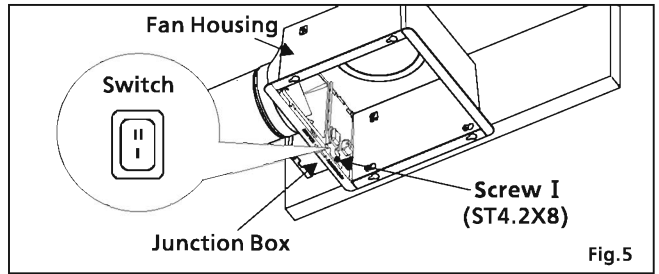

## INSTALLATION FOR FV-07VBB1

1. Insert the Blower / Motor Assembly by sliding it into Adaptor flanges. Then press lock the Blower / Motor Assembly into the Housing Can until the Blower "clicks" into place for temporary fixation. (Fig.7)
2. Secure the Blower / Motor Assembly with 2 Screw I and connect the Molex Plug Connector from the Blower to the Junction Box. (Fig.8)

### CAUTION

- ❗ Before turning on the fan, make sure the connector is inserted at the correct position. Failure to properly connect will result in fan not working. (Fig.8)
- ❗ The Claw of connector must latch to the Rib completely. (Fig.8)

### WARNING

- ❗ The Blower / Motor Assembly must be installed into Housing Can tightly by the 2 Screw I. Failure to secure with screw will affect the grounding.

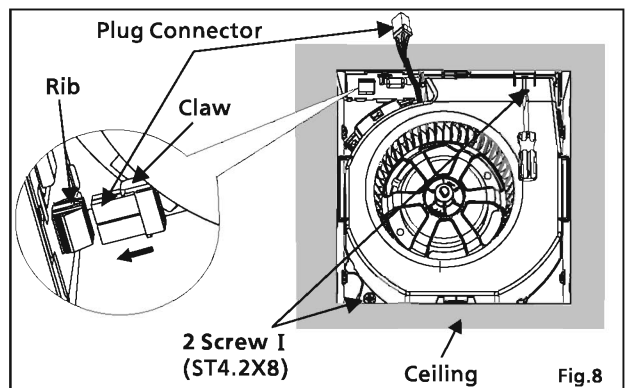
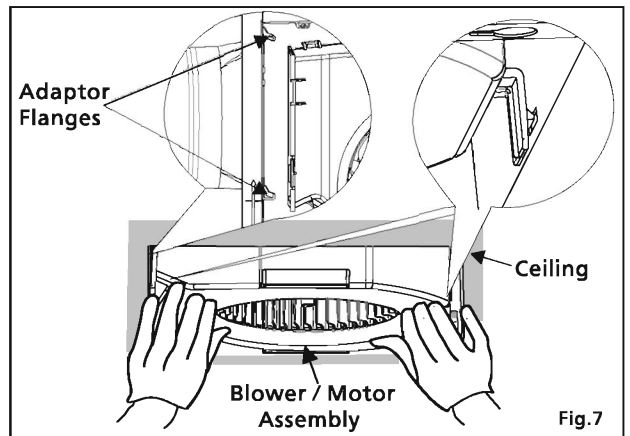

## INSTALLATION FOR FV-07VBB1 CONTINUED

3. Insert the Grille Assembly Mounting springs into the Slots as shown and mount Grille Assembly to Fan Body . (Fig.9)

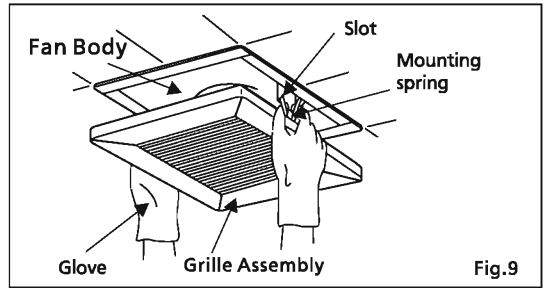

## MAINTENANCE (CLEANING)

### ! WARNING



Disconnect power source before working on unit.

### ! CAUTION



Routine maintenance must be done every year.



Never use gasoline, benzene, thinner or any other such chemicals for cleaning the ventilating fan.



Do not immerse motor in water when cleaning.  
Do not soak resin parts in water over 140°F (60°C).

1. Remove Grille Assembly. (Squeeze Mounting springs and pull down carefully.)(Fig.10)
2. Wash and clean Grille Assembly. (Use non-abrasive kitchen detergent, wipe dry with clean cloth.)(Fig.11)
3. Remove dust and dirt from Fan Body using a Vacuum cleaner. (Fig.12)
4. Using a cloth dampened with kitchen detergent, remove any dirt from Fan Body. Wipe dry with clean cloth. (Fig.13)
5. Replace Grille Assembly.

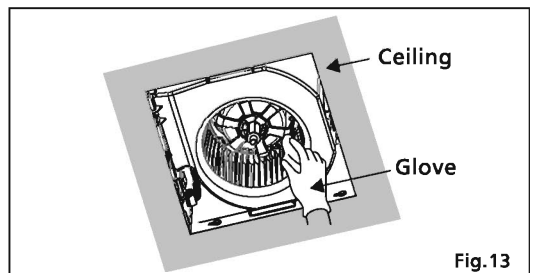
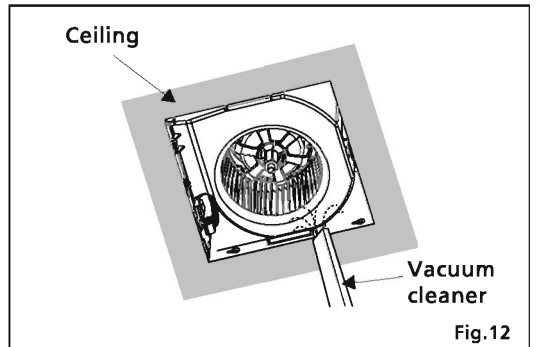
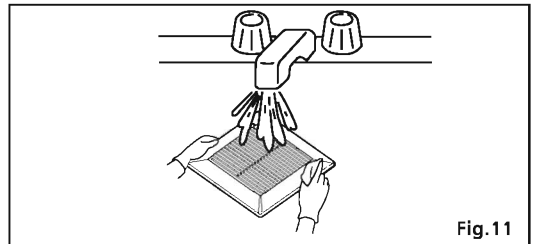
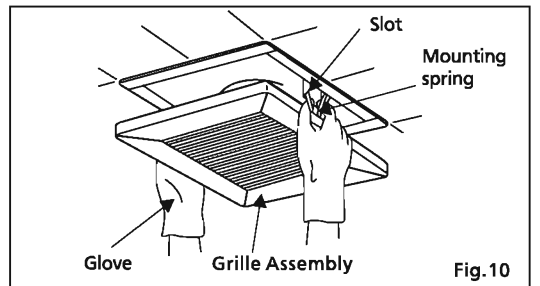

## PRACTICAL GUIDE TO INSTALLATION

Properly insulate the area around the fan to minimize building heat loss and gain. (Fig.14)

Loose fill or batt insulation can be placed directly over the fan housing in the attic. Our fans and fan/light combination units do not create excessive heat that is a common problem with recessed light fixtures or some competitor's fan/light combination. Our efficient, cool-running motors and our fluorescent lamps do not create enough ambient heat to be subjected to these limitations.

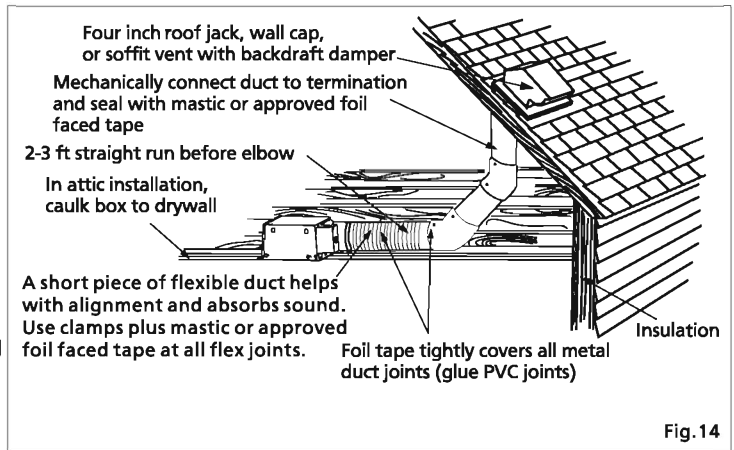

## SPECIFICATIONS

Speed	Air direction	Voltage (V)	Frequency (Hz)	Duct diameter (inches)	Power consumption (W)	Noise (sones)		Air volume (CFM)		Speed (rpm)	Weight (lb./kg)
						0.1" WG	0.25" WG	0.1" WG	0.25" WG		
I (Standard)	Exhaust	120	60	4	20	1.1	1.4	70	50	907	4.4/2.0
II (Boost)	Exhaust	120	60	4	24	1.5	2.0	90	70	1019	

HVI Certified performance based on HVI Procedures 915, 916 and 920.

## PRODUCT SERVICE

**Warning Concerning Removal of Covers.**

The unit should be serviced by qualified technicians only.

Your product is designed and manufactured to ensure a minimum of maintenance.

Should your unit require service or parts, call Panasonic Call Center at 1-866-292-7299 (USA) or 1-800-669-5165 (Canada).

**Panasonic Corporation of North America**

Two Riverfront Plaza, Newark, NJ 07102

[www.panasonic.com](http://www.panasonic.com)

**Panasonic Canada Inc.**

5770 Ambler Drive, Mississauga, Ontario L4W 2T3

[www.panasonic.ca/english/support](http://www.panasonic.ca/english/support)

© Panasonic corporation 2014

Printed in China

X0114-0 07VBA1420